



Caledonian

Fireport

Flame Retardant Cables for Airport Baggage Handling System



TABLE OF CONTENTS

Flame Retardant Power & Control Cables

300/500V XLPE Insulated, LSZH Sheathed Power Cables (single core).....	4
300/500V XLPE Insulated, LSZH Sheathed Power Cables (2-4core).....	7
300/500V XLPE Insulated, LSZH Sheathed, Screened Power Cables (2-4core).....	11
300/500V XLPE Insulated, LSZH Sheathed, Screened Power Cables (multicores).....	15
450/750V LSZH Insulated, Non-sheathed Power Cables (single core).....	18
450/750V XLPE Insulated, LSZH Sheathed Power Cables (2-4core).....	22
450/750V XLPE Insulated, LSZH Sheathed Power Cables (multicores).....	25
450/750V XLPE Insulated, LSZH Sheathed, Screened Power Cables (2-4core).....	28
450/750V XLPE Insulated, LSZH Sheathed, Screened Power Cables (multicores).....	32
600/1000V LSZH Insulated Non-sheathed Power Cables (single core).....	36
600/1000V XLPE Insulated, LSZH Sheathed, Armoured Power Cables (single core).....	41
600/1000V XLPE Insulated, LSZH Sheathed, Armoured Power Cables (single core).....	47
600/1000V XLPE Insulated, LSZH Sheathed, Armoured Power Cables (2-4core).....	51
600/1000V XLPE Insulated, LSZH Sheathed, Armoured Power Cables (multicores).....	58
600/1000V XLPE Insulated, LSZH Sheathed, Screened Power Cables (4core).....	63
600/1000V XLPE Insulated, LSZH Sheathed, Screened Power Cables (3C+3E).....	67
600/1000V XLPE Insulated, LSZH Sheathed, Double steel tape armoured Power Cables (2core).....	71
600/1000V XLPE Insulated, LSZH Sheathed, Double steel tape Armoured Power Cables (3core).....	75
Type Codes For Fire Retardant Power & Control Cable.....	80

Flame Retardant Instrumentation Cables

Flame Retardant Overall Screened Instrumentation Cables (multicores).....	81
Flame Retardant Overall Screened Instrumentation Cables (multipairs).....	84
Flame Retardant Individual and Overall Screened Instrumentation Cables (multipairs).....	88
Flame Retardant Overall Screened, Armoured Instrumentation Cables (multipairs).....	92
Flame Retardant Individual and Overall Screened, Armoured Instrumentation Cables (multipairs).....	96
Instrumentation Cables BS 5308 Part 1 Colour Code.....	100



Flame Retardant Data Cables

Flame Retardant CAT5E Data Cables.....	102
Flame Retardant CAT5E CWB/SWB/SWA Armoured Data Cables.....	105
Flame Retardant CAT6 Data Cables.....	109
Flame Retardant CAT6 CWB/SWB/SWA Armoured Data Cables.....	112

Flame Retardant RS485 Databus Cables

Flame Retardant RS485 Databus Cables.....	116
---	-----

Flame Retardant Bus Cables

Flame Retardant Profibus DP Bus Cables.....	121
Flame Retardant Profibus L2.....	125
Flame Retardant Profibus PA.....	127
Flame Retardant Foundation Fieldbus ISA/SP-50Bus Cables	129
Flame Retardant ASI Bus Cables.....	131
Flame Retardant Profibus SK Bus Cables.....	133

Flame Retardant Optic Fiber Cables

Flame Retardant Plastic Optical Fiber Cables.....	135
Flame Retardant Tight Buffered Distribution Fiber Optic Cables.....	137
Flame Retardant Central Loose Tube Fiber Optic Cables.....	140
Flame Retardant Multi Loose Tube Fiber Optic Cables.....	145
Technical Information For Fiber Optic Cables.....	151
Technical Information.....	155

300/500V XLPE Insulated, LSZH Sheathed Power Cables (single core)

FTX300 05RZ1-R (CU/XLPE/LSZH 300/500V Class 2)

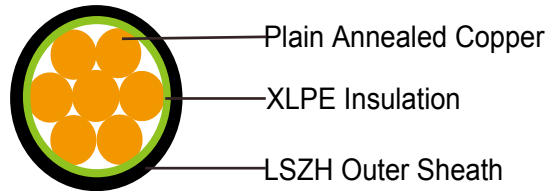
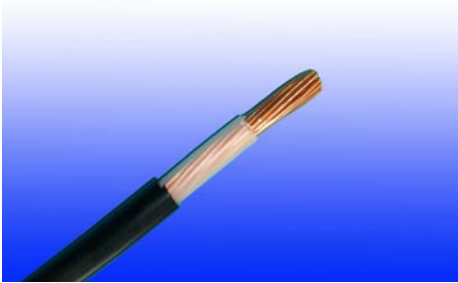

APPLICATION

.The cables are mainly used in the conveyer belts, sensors, X rays, automatic sorters in the airport baggage handling system where high flexibility and heat resistance may be required. Ability to operate at high temperature protect this cables from premature aging due to constant exposure to ambient heat generated in the system, while LSZH properties assure low smoke and corrosive gas in the event of a fire.

STANDARDS

Basic design to IEC 60502-1

FIRE PERFORMANCE

Flame Retardance (Single Vertical Wire Test)	EN 60332-1-2; IEC 60332-1-2; BS EN 60332-1-2; VDE 0482-332-1 ; NBN C 30-004 (cat. F1); NF C32-070-2.1(C2); CEI 20-35/1-2; EN 50265-2-1*; DIN VDE 0482-265-2-1*
Reduced Fire Propagation (Vertically-mounted bundled wires & cable test)	EN 60332-3-24 (cat. C); IEC 60332-3-24; BS EN 60332-3-24; VDE 0482-332-3; NBN C 30-004 (cat. F2); NF C32-070-2.2(C1); CEI 20-22/3-4; EN 50266-2-4*; DIN VDE 0482-266-2-4
Halogen Free	IEC 60754-1; EN 50267-2-1; DIN VDE 0482-267-2-1; CEI 20-37/2-1 ; BS 6425-1*
No Corrosive Gas Emission	IEC 60754-2; EN 50267-2-2; DIN VDE 0482-267-2-2; CEI 20-37/2-2 ; BS 6425-2*
Minimum Smoke Emission	IEC 61034-1&2; EN 61034 -1&2; DIN VDE 0482-1034-1&2; CEI 20-37/3-1&2; EN 50268-1&2*; BS 7622-1&2*
No Toxic gases	NES 02-713; NF C 20-454

Note: Asterisk * denotes superseded standard.



VOLTAGE RATING

300/500V

CABLE CONSTRUCTION

Conductor: Plain annealed copper wire, stranded according to IEC(EN) 60228 class 2.

Insulation: Extruded cross-linked XLPE compound.

Outer Sheath: Thermoplastic LSZH compound type LTS3 as per BS 7655-6.1 (Thermosetting LSZH compound type SW2-SW4 as per BS 7655-2.6 can be offered.)

COLOUR CODE

Insulation Colour as per BS7671: Natural

Sheath Colour: Black or as order

PHYSICAL AND THERMAL PROPERTIES

Temperature range during operation: Max.90°C for XLPE
250°C in short-circuit for 5s max.

Minimum bending radius: 6 x Overall Diameter (unarmoured cable)
10 x Overall Diameter (armoured cable)

CONSTRUCTION PARAMETERS

Conductor		FTX300 05RZ1-R		
No. of Core X Cross Section	No./Nominal Diameter of Strands	Nominal Insulation Thickness	Nominal Overall Diameter	Approx. Weight
Noxmm ²	No./mm	mm	mm	kg/km
1x1.5	7/0.53	0.50	3.8	27
1x2.5	7/0.67	0.50	4.2	37
1x4.0	7/0.85	0.50	4.8	54

ELECTRICAL PROPERTIES

Conductor Operating Temperature : 90°C

Ambient Temperature : 30°C

Current-Carrying Capacities (Amp)

Conductor cross-sectional area	Reference Method 4 (enclosed in conduit in thermally insulating wall etc)	Reference Method 3 (enclosed in conduit on a wall or in trunking etc)	Reference Method 1 (clipped direct)	Reference Method 11 (on a perforated cable tray, horizontal or vertical)	Reference Method 12 (free air)		
					Horizontal flat spaced	Vertical flat spaced	Trefoil

	2 cables, single-phase a.c. or d.c.	3 or 4 cables, 3-phase a.c.	2 cables, single-phase a.c. or d.c.	3 or 4 cables, 3-phase a.c.	2 cables, single-phase a.c. or d.c. flat and touching	3 or 4 cables, 3-phase a.c. flat and touching or trefoil	2 cables, single-phase a.c. or d.c. flat and touching	3 or 4 cables, 3-phase a.c. flat and touching or trefoil	2 cables, single-phase a.c. or d.c. or 3 cables three phase	2 cables, single-phase a.c. or d.c. or 3 cables three phase	3 cables, trefoil 3-phase a.c.	
	1	2	3	4	5	6	7	8	9	10	11	12
mm ²	A	A	A	A	A	A	A	A	A	A	A	A
1.5	18	17	22	19	25	23	-	-	-	-	-	-
2.5	24	23	30	26	34	31	-	-	-	-	-	-
4	33	30	40	35	46	41	-	-	-	-	-	-

Voltage Drop (Per Amp Per Meter)

Nominal Cross Section Area	2 cables d.c.	2 cables, single-phase a.c.		3 or 4 cables, 3-phase a.c.		
		Ref. Methods 3 and 4 (enclosed in conduit etc, in or on a wall)	Ref. Methods 1 and 11 (clipped direct or on trays touching)	Ref. Methods 3 and 4 (enclosed in conduit etc, in or on a wall)	Ref. Methods 1, 11 and 12 (in trefoil)	Ref. Methods 1 and 11 (Flat and touching)
1	2	3	4	5	6	7
mm ²	mV/A/m	mV/A/m	mV/A/m	mV/A/m	mV/A/m	mV/A/m
1.5	31	31	27	27	27	27
2.5	19	19	16	16	16	16
4	33	12	10	10	10	10



Rated Voltage



Standard



Reduced Fire Propagation
NF C32-070-2.2(C1)
IEC60332-3-24/EN50266-2-4



Flame Retardancy
NF C32-070-2.1(C2)
IEC60332-1-2/EN50265-2

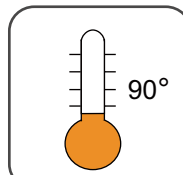

Operating Temperature



Low Toxicity
NES 02-713/NF C 20-454



Low Corrosivity
IEC60754-2
EN50267-2-2/3
NF C 32-074

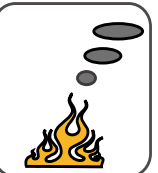

Low Smoke Emission
IEC 61034-1&2
EN 50268-1&2/NF C32-073

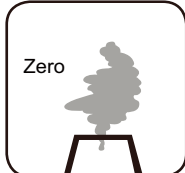

Zero
Halogen Free
IEC60754-1
EN50267-2-1



Highly Flexible



300/500V XLPE Insulated, LSZH Sheathed Power Cables (2-4core)

FTX200 05RZ1-R (CU/XLPE/LSZH 300/500V Class 2)

FTX200 05RZ1MZ1-R (CU/XLPE/LSZH/SWA/LSZH 300/500V Class 2)

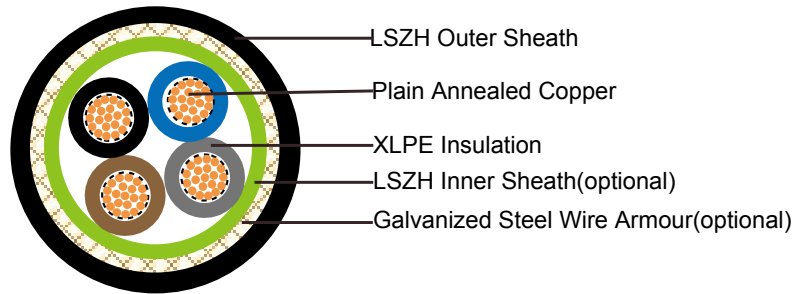
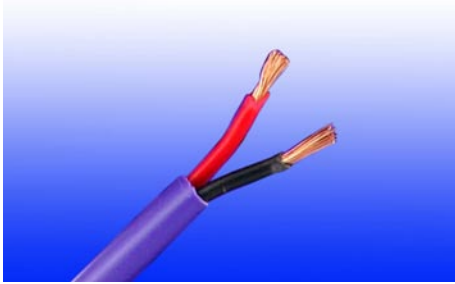

APPLICATION

The cables are mainly used in the conveyer belts, sensors, X rays, automatic sorters in the airport baggage handling system where high flexibility and heat resistance may be required. Ability to operate at high temperature protect this cables from premature aging due to constant exposure to ambient heat generated in the system, while LSZH properties assure low smoke and corrosive gas in the event of a fire.

STANDARDS

Basic design adapted to IEC 60502-1; BS 6724

FIRE PERFORMANCE

Flame Retardance (Single Vertical Wire Test)	EN 60332-1-2; IEC 60332-1-2; BS EN 60332-1-2; VDE 0482-332-1 ; NBN C 30-004 (cat. F1); NF C32-070-2.1(C2); CEI 20-35/1-2; EN 50265-2-1*; DIN VDE 0482-265-2-1*
Reduced Fire Propagation (Vertically-mounted bundled wires & cable test)	EN 60332-3-24 (cat. C); IEC 60332-3-24; BS EN 60332-3-24; VDE 0482-332-3; NBN C 30-004 (cat. F2); NF C32-070-2.2(C1); CEI 20-22/3-4; EN 50266-2-4*; DIN VDE 0482-266-2-4
Halogen Free	IEC 60754-1; EN 50267-2-1; DIN VDE 0482-267-2-1; CEI 20-37/2-1 ; BS 6425-1*
No Corrosive Gas Emission	IEC 60754-2; EN 50267-2-2; DIN VDE 0482-267-2-2; CEI 20-37/2-2 ; BS 6425-2*
Minimum Smoke Emission	IEC 61034-1&2; EN 61034 -1&2; DIN VDE 0482-1034-1&2; CEI 20-37/3-1&2; EN 50268-1&2*; BS 7622-1&2*
No Toxic gases	NES 02-713; NF C 20-454

Note: Asterisk * denotes superseded standard.

VOLTAGE RATING

300/500V

CABLE CONSTRUCTION

Conductor: Plain annealed copper wire, stranded according to IEC(EN) 60228 class 2.

Insulation: Extruded cross-linked XLPE compound.

Inner Sheath (optional): LSZH Compound

Armouring (optional): Galvanized Steel Wire

Outer Sheath: Thermoplastic LSZH compound type LTS3 as per BS 7655-6.1 (Thermosetting LSZH compound type SW2-SW4 as per BS 7655-2.6 can be offered.)

COLOUR CODE

Insulation Colour as per BS7671

	with earth conductor	without earth conductor
2Cores	-	Brown,Blue
3Cores	Yellow/Green,Brown,Blue	Brown,Gray,Black
4Cores	Yellow/Green,Brown,Gray,Black	Brown,Gray,Black,Blue
5Cores	Yellow/Green,Brown,Gray,Black,Blue	Brown,Gray,Black,Blue,Black
above 5 Cores	Yellow/Green,Black Numbered	Black Numbered

Sheath Colour: Black or as order.

CONSTRUCTION PARAMETERS

Conductor			FTX200 05RZ1-R		FTX200 05RZ1MZ1-R			
No. of Core X Cross Section	No./Nominal Diameter of Strands	Nominal Insulation Thickness	Unarmoured		Armoured			
			Nominal Overall Diameter	Approx. Weight	Diameter Under Armour	Armour Wire Diameter	Nominal Overall Diameter	Approx. Weight
Noxmm ²	No./mm	mm	mm	kg/km	mm	mm	mm	kg/km
2x1.5	7/0.53	0.50	6.5	65	6.5	0.9	11.2	246
2x2.5	7/0.67	0.50	7.3	91	7.3	0.9	12.0	292
2x4	7/0.85	0.50	8.4	131	8.4	0.9	13.1	360
3x1.5	7/0.53	0.50	6.9	81	6.9	0.9	11.6	275
3x2.5	7/0.67	0.50	7.8	116	7.8	0.9	12.5	331
3x4	7/0.85	0.50	9.0	169	9.0	0.9	13.7	413
4x1.5	7/0.53	0.50	7.6	101	7.6	0.9	12.3	309
4x2.5	7/0.67	0.50	8.6	144	8.6	0.9	13.3	380
4x4	7/0.85	0.50	9.9	213	9.9	0.9	14.6	479

ELECTRICAL PROPERTIES

Conductor Operating Temperature : 90°C

Ambient Temperature : 30°C



FTX200 05RZ1-R

Current-Carrying Capacities (Amp)

Conductor cross-sectional area	Reference Method 4 (enclosed in conduit in thermally insulating wall etc)		Reference Method 3 (enclosed in conduit on a wall or in trunking etc)		Reference Method 1 (clipped direct)		Reference Method 11 (on a perforated cable tray, horizontal or vertical)		Reference Method 12 (free air)		
	2 cables, single-phase a.c. or d.c.	3 or 4 cables, 3-phase a.c.	2 cables, single-phase a.c. or d.c.	3 or 4 cables, 3-phase a.c.	2 cables, single-phase a.c. or d.c. flat and touching	3 or 4 cables, 3-phase a.c. flat and touching or trefoil	2 cables, single-phase a.c. or d.c. or flat and touching	3 or 4 cables, 3-phase a.c. flat and touching or trefoil	Horizontal flat spaced	Vertical flat spaced	Trefoil
1	2	3	4	5	6	7	8	9	10	11	12
mm ²	A	A	A	A	A	A	A	A	A	A	A
1.5	18	17	22	19	25	23	-	-	-	-	-
2.5	24	23	30	26	34	31	-	-	-	-	-
4	33	30	40	35	46	41	-	-	-	-	-

Voltage Drop (Per Amp Per Meter)

Nominal Cross Section Area	2 cables d.c.	2 cables, single-phase a.c.		3 or 4 cables, 3-phase a.c.		
		Ref. Methods 3 and 4 (enclosed in conduit etc, in or on a wall)	Ref. Methods 1 and 11 (clipped direct or on trays touching)	Ref. Methods 3 and 4 (enclosed in conduit etc, in or on a wall)	Ref. Methods 1, 11 and 12 (in trefoil)	Ref. Methods 1 and 11 (Flat and touching)
1	2	3	4	5	6	7
mm ²	mV/A/m	mV/A/m	mV/A/m	mV/A/m	mV/A/m	mV/A/m
1.5	31	31	27	27	27	27
2.5	19	19	16	16	16	16
4	33	12	10	10	10	10

FTX200 05RZ1MZ1-R

Current-Carrying Capacities (Amp)

Conductor cross-sectional area	Reference Method 1 (clipped direct)		Reference Method 11 (on a perforated horizontal cable tray or Reference Method 13 [free air])		In single-way ducts		Laid direct in ground	
	one 2-core cable single phase a.c. or d.c.	one 3-core or 4-core cable 3-phase a.c.	one 2-core cable single phase a.c. or d.c.	one 3-core or 4-core cable 3-phase a.c.	one 2-core cable single phase a.c. or d.c.	one 3-core or 4-core cable 3-phase a.c.	one 2-core cable single phase a.c. or d.c.	one 3-core or 4-core cable 3-phase a.c.
1	2	3	4	5	6	7	8	9
mm ²	A	A	A	A	A	A	A	A
1.5	27	23	29	25	-	23	-	28
2.5	36	31	39	33	-	30	-	36
4	49	42	52	44	-	40	-	48

Voltage Drop (Per Amp Per Meter)

Nominal Cross Section Area	2 cables d.c.	2 cables, single-phase a.c.	3 or 4 cables, 3-phase a.c.	2 cables, single-phase a.c.	3 or 4 cables, 3-phase a.c.
				In ducts or in ground	In ducts or in ground
1	2	3	4	5	6
mm ²	mV/A/m	mV/A/m	mV/A/m	mV/A/m	mV/A/m
1.5	31	31	27	31	25
2.5	19	19	16	19	15
4	12	12	10	12	9.7



300/500V

Rated Voltage



IEC 60502-1

Standard



BS 6724

Standard



Reduced Fire Propagation
NF C32-070-2.2(C1)
IEC60332-3-24/EN50266-2-4



Flame Retardancy
NF C32-070-2.1(C2)
IEC60332-1-2/EN50265-2-1



Low Toxicity
NES 02-713/NF C 20-454



Low Corrosivity
IEC60754-2
EN50267-2-2/3
NF C 32-074



Low Smoke Emission
IEC 61034-1&2
EN 50268-1&2/NF C32-073

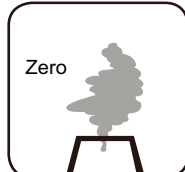

Halogen Free
IEC60754-1
EN50267-2-1

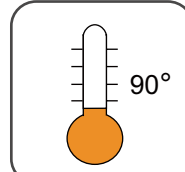

Operating Temperature



Highly Flexible



300/500V XLPE Insulated, LSZH Sheathed, Screened Power Cables (2-4core)

FTX200 05ROZ1-R (CU/XLPE/OSCR/LSZH 300/500V Class 2)

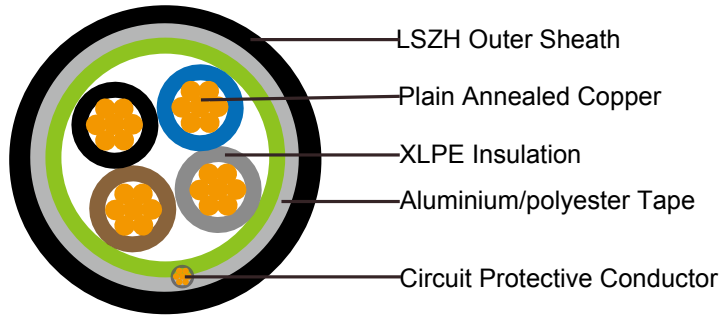
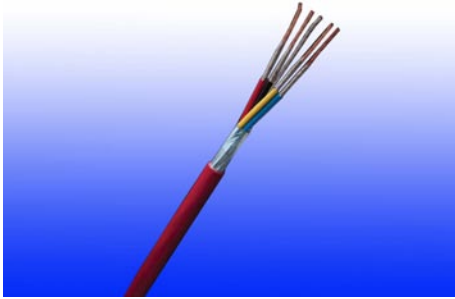

APPLICATION

The cables are mainly used in the conveyer belts, sensors, X rays, automatic sorters in the airport baggage handling system where high flexibility and heat resistance may be required. Ability to operate at high temperature protect this cables from premature aging due to constant exposure to ambient heat generated in the system, while LSZH properties assure low smoke and corrosive gas in the event of a fire.

STANDARDS

Basic design to BS 5308

FIRE PERFORMANCE

Flame Retardance (Single Vertical Wire Test)	EN 60332-1-2; IEC 60332-1-2; BS EN 60332-1-2; VDE 0482-332-1 ; NBN C 30-004 (cat. F1); NF C32-070-2.1(C2); CEI 20-35/1-2; EN 50265-2-1*; DIN VDE 0482-265-2-1*
Reduced Fire Propagation (Vertically-mounted bundled wires & cable test)	EN 60332-3-24 (cat. C); IEC 60332-3-24; BS EN 60332-3-24; VDE 0482-332-3; NBN C 30-004 (cat. F2); NF C32-070-2.2(C1); CEI 20-22/3-4; EN 50266-2-4*; DIN VDE 0482-266-2-4
Halogen Free	IEC 60754-1; EN 50267-2-1; DIN VDE 0482-267-2-1; CEI 20-37/2-1 ; BS 6425-1*
No Corrosive Gas Emission	IEC 60754-2; EN 50267-2-2; DIN VDE 0482-267-2-2; CEI 20-37/2-2 ; BS 6425-2*
Minimum Smoke Emission	IEC 61034-1&2; EN 61034 -1&2; DIN VDE 0482-1034-1&2; CEI 20-37/3-1&2; EN 50268-1&2*; BS 7622-1&2*
No Toxic gases	NES 02-713; NF C 20-454

Note: Asterisk * denotes superseded standard.

VOLTAGE RATING

300/500V

CABLE CONSTRUCTION

Conductor: Plain annealed copper wire, stranded according to IEC(EN) 60228 class 2.

Insulation: Extruded cross-linked XLPE compound.

Filler, binder(if any): PP, Mylar tape

Circuit Protective Conductor: Annealed plain copper (class 2)

Overall Screen: Aluminium/polyester tape

Outer Sheath: Thermoplastic LSZH compound type LTS3 as per BS 7655-6.1 (Thermosetting LSZH compound type SW2-SW4 as per BS 7655-2.6 can be offered.)

COLOUR CODE

Insulation Colour as per BS7671

	with earth conductor	without earth conductor
2Cores	-	Brown,Blue
3Cores	Yellow/Green,Brown,Blue	Brown,Gray,Black
4Cores	Yellow/Green,Brown,Gray,Black	Brown,Gray,Black,Blue
5Cores	Yellow/Green,Brown,Gray,Black,Blue	Brown,Gray,Black,Blue,Black
above 5 Cores	Yellow/Green,Black Numbered	Black Numbered

Sheath Colour: Black or as order.

PHYSICAL AND THERMAL PROPERTIES

Temperature range during operation: Max.90°C for XLPE
250°C in short-circuit for 5s max.

Minimum bending radius: 6 x Overall Diameter

CONSTRUCTION PARAMETERS

Conductor			FTX200 05ROZ1-R					
No. Of Core X Cross Section	No./ Nominal Diameter Of Strands	Nominal Overall Diameter Conductor	Nominal Insulation Thickness	Cross-Section Area Of Circuit Protective Conductor	Nominal Sheath Thickness	Nominal Overall Diameter	Max.Dc Resistance Of Conductor @20°C	Approx. Weight
Noxmm ²	No./mm	mm	mm	mm ²	mm	mm	Ω/km	kg/km
2x1.0	7/0.44	1.32	0.6	1.0	0.9	8.1	18.1	79
2x1.5	7/0.53	1.59	0.7	1.5	0.9	9.1	12.1	102
2x2.5	7/0.67	2.01	0.8	2.5	1.0	10.5	7.41	146
2x4.0	7/0.85	2.55	0.8	4.0	1.1	11.8	4.61	205



3x1.0	7/0.44	1.32	0.6	1.0	0.9	8.6	18.1	98
3x1.5	7/0.53	1.59	0.7	1.5	0.9	9.6	12.1	129
3x2.5	7/0.67	2.01	0.8	2.5	1.0	11.1	7.41	185
3x4.0	7/0.85	2.55	0.8	4.0	1.1	12.5	4.61	262
4x1.0	7/0.44	132	0.6	1.0	1.0	9.5	18.1	123
4x1.5	7/0.53	1.59	0.7	1.5	1.0	10.6	12.1	162
4x2.5	7/0.67	2.01	0.8	2.5	1.1	12.3	7.41	233
4x4.0	7/0.85	2.55	0.8	4.0	1.2	13.9	4.61	329

ELECTRICAL PROPERTIES

Conductor Operating Temperature : 90°C

Ambient Temperature : 30°C

Current-Carrying Capacities (Amp)

Conductor cross-sectional area	Reference Method 4 (enclosed in conduit in thermally insulating wall etc)		Reference Method 3 (enclosed in conduit on a wall or in trunking etc)		Reference Method 1 (clipped direct)		Reference Method 11 (on a perforated cable tray, horizontal or vertical)		Reference Method 12 (free air)		
									Horizontal flat spaced	Vertical flat spaced	Trefoil
	2 cables, single-phase a.c. or d.c.	3 or 4 cables, 3-phase a.c.	2 cables, single-phase a.c. or d.c.	3 or 4 cables, 3-phase a.c.	2 cables, single-phase a.c. or d.c. flat and touching	3 or 4 cables, 3-phase a.c. flat and touching or trefoil	2 cables, single-phase a.c. or d.c. or flat and touching	3 or 4 cables, 3-phase a.c. flat and touching or trefoil	2 cables, single-phase a.c. or d.c. or 3 cables three phase	2 cables, single-phase a.c. or d.c. or 3 cables three phase	3 cables, trefoil 3-phase a.c.
1	2	3	4	5	6	7	8	9	10	11	12
mm ²	A	A	A	A	A	A	A	A	A	A	A
1.5	18	17	22	19	25	23	-	-	-	-	-
2.5	24	23	30	26	34	31	-	-	-	-	-
4	33	30	40	35	46	41	-	-	-	-	-

Voltage Drop (Per Amp Per Meter)

Nominal Cross Section Area	2 cables d.c.	2 cables, single-phase a.c.		3 or 4 cables, 3-phase a.c.		
		Ref. Methods 3 and 4 (enclosed in conduit etc, in or on a wall)	Ref. Methods 1 and 11 (clipped direct or on trays touching)	Ref. Methods 3 and 4 (enclosed in conduit etc, in or on a wall)	Ref. Methods 1, 11 and 12 (in trefoil)	Ref. Methods 1 and 11 (Flat and touching)
1	2	3	4	5	6	7
mm ²	mV/A/m	mV/A/m	mV/A/m	mV/A/m	mV/A/m	mV/A/m
1.5	31	31	27	27	27	27
2.5	19	19	16	16	16	16
4	33	12	10	10	10	10



Rated Voltage



Standard



Reduced Fire Propagation
NF C32-070-2.2(C1)
IEC60332-3-24/EN50266-2-4



Flame Retardancy
NF C32-070-2.1(C2)
IEC60332-1-2/EN50265-2-1

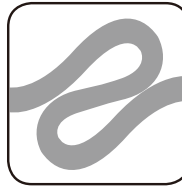

Highly Flexible



Low Toxicity
NES 02-713/NF C 20-454



Low Corrosivity
IEC60754-2
EN50267-2-2/3
NF C 32-074



Low Smoke Emission
IEC 61034-1&2
EN 50268-1&2/NF C32-073

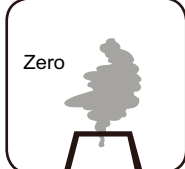

Halogen Free
IEC60754-1
EN50267-2-1

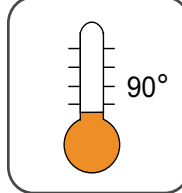

Operating Temperature





300/500V XLPE Insulated, LSZH Sheathed, Screened Power Cables (multicores)

FTX200 05ROZ1-R (CU/XLPE/OSCR/LSZH 300/500V Class 2)

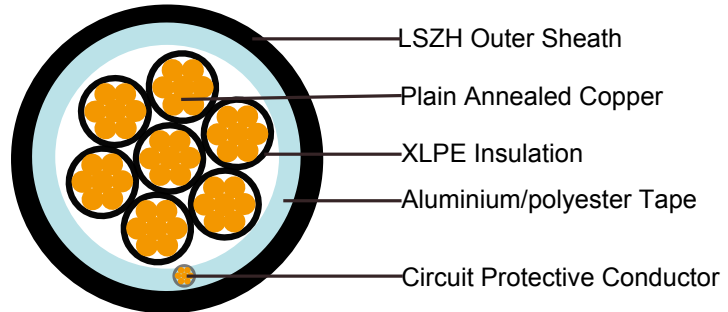
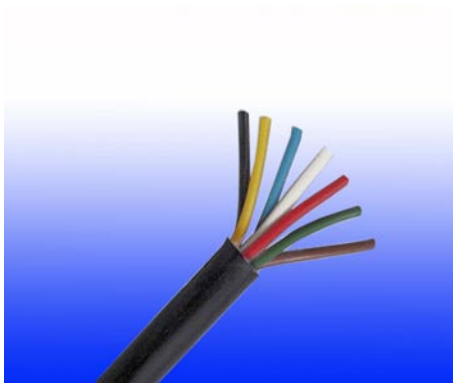

APPLICATION

The cables are mainly used in the conveyer belts, sensors, X rays, automatic sorters in the airport baggage handling system where high flexibility and heat resistance may be required. Ability to operate at high temperature protect this cables from premature aging due to constant exposure to ambient heat generated in the system, while LSZH properties assure low smoke and corrosive gas in the event of a fire.

STANDARDS

Basic design to BS 5308

FIRE PERFORMANCE

Flame Retardance (Single Vertical Wire Test)	EN 60332-1-2; IEC 60332-1-2; BS EN 60332-1-2; VDE 0482-332-1 ; NBN C 30-004 (cat. F1); NF C32-070-2.1(C2); CEI 20-35/1-2; EN 50265-2-1*; DIN VDE 0482-265-2-1*
Reduced Fire Propagation (Vertically-mounted bundled wires & cable test)	EN 60332-3-24 (cat. C); IEC 60332-3-24; BS EN 60332-3-24; VDE 0482-332-3; NBN C 30-004 (cat. F2); NF C32-070-2.2(C1); CEI 20-22/3-4; EN 50266-2-4*; DIN VDE 0482-266-2-4
Halogen Free	IEC 60754-1; EN 50267-2-1; DIN VDE 0482-267-2-1; CEI 20-37/2-1 ; BS 6425-1*
No Corrosive Gas Emission	IEC 60754-2; EN 50267-2-2; DIN VDE 0482-267-2-2; CEI 20-37/2-2 ; BS 6425-2*
Minimum Smoke Emission	IEC 61034-1&2; EN 61034 -1&2; DIN VDE 0482-1034-1&2; CEI 20-37/3-1&2; EN 50268-1&2*; BS 7622-1&2*
No Toxic gases	NES 02-713; NF C 20-454

Note: Asterisk * denotes superseded standard.

VOLTAGE RATING

300/500V

CABLE CONSTRUCTION

Conductor: Plain annealed copper wire, stranded according to IEC(EN) 60228 class 2.

Insulation: Extruded cross-linked XLPE compound.

Filler, binder(if any): PP, Mylar tape

Circuit Protective Conductor: Annealed plain copper (class 2)

Overall Screen: Aluminium/polyester tape

Outer Sheath: Thermoplastic LSZH compound type LTS3 as per BS 7655-6.1 (Thermosetting LSZH compound type SW2-SW4 as per BS 7655-2.6 can be offered.)

COLOUR CODE

Insulation Colour as per BS7671

	with earth conductor	without earth conductor
2Cores	-	Brown,Blue
3Cores	Yellow/Green,Brown,Blue	Brown,Gray,Black
4Cores	Yellow/Green,Brown,Gray,Black	Brown,Gray,Black,Blue
5Cores	Yellow/Green,Brown,Gray,Black,Blue	Brown,Gray,Black,Blue,Black
above 5 Cores	Yellow/Green,Black Numbered	Black Numbered

Sheath Colour: Black or as order.

PHYSICAL AND THERMAL PROPERTIES

Temperature range during operation: Max.90°C for XLPE
250°C in short-circuit for 5s max.

Minimum bending radius: 6 x Overall Diameter

CONSTRUCTION PARAMETERS

Conductor			FTX200 05ROZ1-R					
No. Of Core X Cross Section	No./ Nominal Diameter Of Strands	Nominal Overall Diameter Conductor	Nominal Insulation Thickness	Cross-Section Area Of Circuit Protective Conductor	Nominal Sheath Thickness	Nominal Overall Diameter	Max.Dc Resistance Of Conductor @20°C	Approx. Weight
Noxmm ²	No./mm	mm	mm	mm ²	mm	mm	Ω/km	Kg/km
7x1.0	7i0.44	1.32	0.6	1.0	1.0	11.2	18.1	186
7x1.5	7i0.53	1.59	0.7	1.5	1.1	12.9	12.1	253
7x2.5	7i0.67	2.01	0.8	2.5	1.2	14.9	7.41	365
12x1.5	7i0.53	1.59	0.7	1.5	1.2	16.8	12.1	404
12x2.5	7i0.67	2.01	0.8	2.5	1.4	19.8	7.41	595
19x1.5	7i0.53	1.59	0.7	1.5	1.3	19.7	12.1	600
19x2.5	7i0.67	2.01	0.8	2.5	1.5	23.2	7.41	885

ELECTRICAL PROPERTIES

Conductor Operating Temperature : 90°C

Ambient Temperature : 30°C



Current-Carrying Capacities (Amp)

Conductor cross-sectional area	Reference Method 4 (enclosed in conduit in thermally insulating wall etc)		Reference Method 3 (enclosed in conduit on a wall or in trunking etc)		Reference Method 1 (clipped direct)		Reference Method 11 (on a perforated cable tray, horizontal or vertical)		Reference Method 12 (free air)		
	2 cables, single-phase a.c. or d.c.	3 or 4 cables, 3-phase a.c.	2 cables, single-phase a.c. or d.c.	3 or 4 cables, 3-phase a.c.	2 cables, single-phase a.c. or d.c. flat and touching	3 or 4 cables, 3-phase a.c. flat and touching or trefoil	2 cables, single-phase a.c. or d.c. flat and touching	3 or 4 cables, 3-phase a.c. flat and touching or trefoil	Horizontal flat spaced	Vertical flat spaced	Trefoil
1	2	3	4	5	6	7	8	9	10	11	12
mm ²	A	A	A	A	A	A	A	A	A	A	A
1.5	18	17	22	19	25	23	-	-	-	-	-
2.5	24	23	30	26	34	31	-	-	-	-	-

Voltage Drop (Per Amp Per Meter)

Nominal Cross Section Area	2 cables d.c.	2 cables, single-phase a.c.		3 or 4 cables, 3-phase a.c.		
		Ref. Methods 3 and 4 (enclosed in conduit etc, in or on a wall)	Ref. Methods 1 and 11 (clipped direct or on trays touching)	Ref. Methods 3 and 4 (enclosed in conduit etc, in or on a wall)	Ref. Methods 1, 11 and 12 (in trefoil)	Ref. Methods 1 and 11 (Flat and touching)
1	2	3	4	5	6	7
mm ²	mV/A/m	mV/A/m	mV/A/m	mV/A/m	mV/A/m	mV/A/m
1.5	31	31	27	27	27	27
2.5	19	19	16	16	16	16

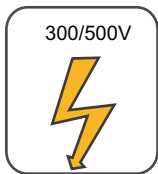

300/500V

Rated Voltage



BS 5308

Standard



Reduced Fire Propagation
NF C32-070-2.2(C1)
IEC60332-3-24/EN50266-2-4



Flame Retardancy
NF C32-070-2.1(C2)
IEC60332-1-2/EN50265-2-1



Highly Flexible



Low Toxicity
NES 02-713/NF C 20-454



Low Corrosivity
IEC60754-2
EN50267-2-2/3
NF C 32-074



Low Smoke Emission
IEC 61034-1&2
EN 50268-1&2/NF C32-073

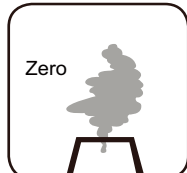

Halogen Free
IEC60754-1
EN50267-2-1

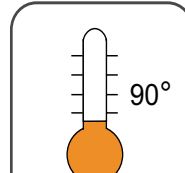

Operating Temperature

450/750V LSZH Insulated, Non-sheathed Power Cables (single core)

FTX100 07Z1-R (CU/LSZH 450/750V Class 2)

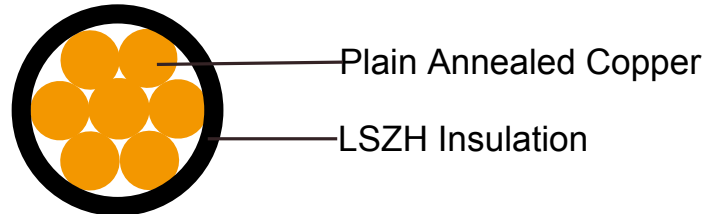
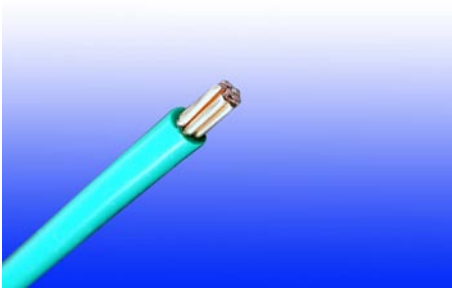

APPLICATION

The cables are mainly used in the conveyer belts, sensors, X rays, automatic sorters in the airport baggage handling system where high flexibility and heat resistance may be required. Ability to operate at high temperature protect this cables from premature aging due to constant exposure to ambient heat generated in the system, while LSZH properties assure low smoke and corrosive gas in the event of a fire.

STANDARDS

Basic design to BS 7211

FIRE PERFORMANCE

Flame Retardance (Single Vertical Wire Test)	EN 60332-1-2; IEC 60332-1-2; BS EN 60332-1-2; VDE 0482-332-1 ; NBN C 30-004 (cat. F1); NF C32-070-2.1(C2); CEI 20-35/1-2; EN 50265-2-1*; DIN VDE 0482-265-2-1*
Reduced Fire Propagation (Vertically-mounted bundled wires & cable test)	EN 60332-3-24 (cat. C); IEC 60332-3-24; BS EN 60332-3-24; VDE 0482-332-3; NBN C 30-004 (cat. F2); NF C32-070-2.2(C1); CEI 20-22/3-4; EN 50266-2-4*; DIN VDE 0482-266-2-4
Halogen Free	IEC 60754-1; EN 50267-2-1; DIN VDE 0482-267-2-1; CEI 20-37/2-1 ; BS 6425-1*
No Corrosive Gas Emission	IEC 60754-2; EN 50267-2-2; DIN VDE 0482-267-2-2; CEI 20-37/2-2 ; BS 6425-2*
Minimum Smoke Emission	IEC 61034-1&2; EN 61034 -1&2; DIN VDE 0482-1034-1&2; CEI 20-37/3-1&2; EN 50268-1&2*; BS 7622-1&2*
No Toxic gases	NES 02-713; NF C 20-454

Note: Asterisk * denotes superseded standard.

VOLTAGE RATING

450/750V



CABLE CONSTRUCTION

Conductor: Plain annealed copper wire, stranded according to IEC(EN) 60228 class 2.

Insulation: LSZH compound

COLOUR CODE

Insulation Colour as per BS7671: Natural

Sheath Colour: Black or as order.

PHYSICAL AND THERMAL PROPERTIES

Temperature range during operation: Max.90°C
250°C in short-circuit for 5s max.

Minimum bending radius: 6 x Overall Diameter

CONSTRUCTION PARAMETERS

Conductor		FTX100 07Z1-R		
No. of Core X Cross Section	No./Nominal Diameter of Strands	Nominal Insulation Thickness	Nominal Overall Diameter	Approx. Weight
Noxmm ²	No./mm	mm	mm	kg/km
1x1.5	7/0.53	0.7	3.1	23
1x2.5	7/0.67	0.8	3.7	35
1x4	7/0.85	0.8	4.3	52
1x6	7/1.04	0.8	4.8	73
1x10	7/1.35	1.0	6.2	120
1x16	7/1.70	1.0	7.2	180
1x25	7/2.24	1.2	9.0	285
1x35	19/1.53	1.2	10.2	375
1x50	19/1.78	1.4	12.0	510
1x70	19/2.14	1.4	14.0	720
1x95	19/2.52	1.6	16.0	995
1x120	37/2.03	1.6	18.0	1230
1x150	37/2.25	1.8	20.0	1520
1x185	37/2.52	2.0	22.0	1900
1x240	61/2.25	2.2	25.0	2480
1x300	61/2.52	2.4	28.0	3100
1x400	61.2.85	2.6	31.5	3950
1x500	61/3.20	2.8	35.0	4950
1x630	127/2.52	2.8	39.0	6360

ELECTRICAL PROPERTIES

Conductor Operating Temperature : 90°C

Ambient Temperature : 30°C
Current-Carrying Capacities (Amp)

Conductor cross-sectional area	Reference Method 4 (enclosed in conduit in thermally insulating wall etc)		Reference Method 3 (enclosed in conduit on a wall or in trunking etc)		Reference Method 1 (clipped direct)		Reference Method 11 (on a perforated cable tray, horizontal or vertical)		Reference Method 12 (free air)		
									Horizontal flat spaced	Vertical flat spaced	Trefoil
	2 cables, single-phase a.c. or d.c.	3 or 4 cables, 3-phase a.c.	2 cables, single-phase a.c. or d.c.	3 or 4 cables, 3-phase a.c.	2 cables, single-phase a.c. or d.c. flat and touching	3 or 4 cables, 3-phase a.c. flat and touching or trefoil	2 cables, single-phase a.c. or d.c. or flat and touching	3 or 4 cables, 3-phase a.c. flat and touching or trefoil	2 cables, single-phase a.c. or d.c. or 3 cables three phase	2 cables, single-phase a.c. or d.c. or 3 cables three phase	3 cables, trefoil 3-phase a.c.
1	2	3	4	5	6	7	8	9	10	11	12
mm ²	A	A	A	A	A	A	A	A	A	A	A
1.5	18	17	22	19	25	23	-	-	-	-	-
2.5	24	23	30	26	34	31	-	-	-	-	-
4	33	30	40	35	46	41	-	-	-	-	-
6	43	39	51	45	59	54	-	-	-	-	-
10	58	53	71	63	81	74	-	-	-	-	-
16	76	70	95	85	109	99	-	-	-	-	-
25	100	91	126	111	143	130	158	140	183	163	138
35	125	111	156	138	176	161	195	176	226	203	171
50	149	135	189	168	228	209	293	215	274	246	209
70	189	170	240	214	293	268	308	279	351	318	270
95	228	205	290	259	355	326	375	341	426	389	330
120	263	235	336	299	413	379	436	398	495	453	385
150	300	270	375	328	476	436	505	461	570	524	445
185	341	306	426	370	545	500	579	530	651	600	511
240	400	358	500	433	644	590	686	630	769	711	606
300	459	410	573	493	743	681	794	730	886	824	701
400	-	-	684	584	868	793	915	849	1065	994	820
500	-	-	783	666	990	904	1044	973	1228	1150	936
630	-	-	900	764	1130	1033	1191	1115	1423	1338	1069

Voltage Drop (Per Amp Per Meter)

Nominal Cross Section Area	2 cables d.c.	2 cables, single-phase a.c.		3 or 4 cables, 3-phase a.c.		
		Ref. Methods 3 and 4 (enclosed in conduit etc, in or on a wall)	Ref. Methods 1 and 11 (clipped direct or on trays touching)	Ref. Methods 3 and 4 (enclosed in conduit etc, in or on a wall)	Ref. Methods 1, 11 and 12 (in trefoil)	Ref. Methods 1 and 11 (Flat and touching)



Caledonian

Flame Retardant Power & Control Cables

www.caledonian-cables.co.uk www.addison-cables.com



1	2	3			4			5			6			7		
mm ²	mV/A/m	mV/A/m			mV/A/m			mV/A/m			mV/A/m			mV/A/m		
1.5	31	31			27			27			27			27		
2.5	19	19			16			16			16			16		
4	33	12			10			10			10			10		
6	7.8	7.9			6.8			6.8			6.8			6.8		
10	4.7	4.7			4.7			4			4			4		
16	2.9	2.9			2.9			2.5			2.5			2.5		
		r	x	z	r	x	z	r	x	z	r	x	z	r	x	z
25	1.85	1.85	0.31	1.9	1.85	0.19	1.85	1.6	0.27	1.65	1.6	0.165	1.6	1.6	0.19	1.6
35	1.35	1.35	0.29	1.35	1.35	0.18	1.35	1.15	0.25	1.15	1.15	0.155	1.5	1.15	0.18	1.15
50	0.99	1	0.29	1.05	0.99	0.18	1	0.87	0.25	0.9	0.86	0.155	0.87	0.86	0.18	0.87
70	0.68	0.7	0.28	0.75	0.68	0.175	0.71	0.6	0.24	0.65	0.59	0.15	0.61	0.59	0.175	0.62
95	0.49	0.51	0.27	0.58	0.49	0.17	0.52	0.44	0.23	0.5	0.43	0.145	0.45	0.43	0.17	0.46
120	0.39	0.41	0.26	0.48	0.39	0.165	0.43	0.35	0.23	0.42	0.34	0.14	0.37	0.34	0.165	0.38
150	0.32	0.33	0.26	0.43	0.32	0.165	0.36	0.29	0.23	0.37	0.28	0.14	0.31	0.28	0.165	0.32
185	0.25	0.27	0.26	0.37	0.26	0.165	0.3	0.23	0.23	0.32	0.22	0.14	0.26	0.22	0.165	0.28
240	0.19	0.21	0.26	0.33	0.2	0.16	0.25	0.185	0.22	0.29	0.17	0.14	0.22	0.17	0.165	0.24
300	0.155	0.175	0.25	0.31	0.16	0.16	0.22	0.15	0.22	0.27	0.14	0.14	0.195	0.135	0.16	0.21
400	0.12	0.14	0.25	0.29	0.13	0.155	0.2	0.125	0.22	0.25	0.11	0.135	0.175	0.11	0.16	0.195
500	0.093	0.12	0.25	0.28	0.105	0.155	0.185	0.1	0.22	0.24	0.09	0.135	0.16	0.088	0.16	0.18
630	0.072	0.1	0.25	0.27	0.086	0.155	0.175	0.088	0.21	0.23	0.074	0.135	0.15	0.071	0.16	0.17

Note :

r = conductor resistance at operating temperature

x = reactance

z = impedance



450/750V

Rated Voltage



BS 7211

Standard



Reduced Fire Propagation
NF C32-070-2.2(C1)
IEC60332-3-24
EN50266-2-4



Flame Retardancy
NF C32-070-2.1(C2)
IEC60332-1-2/EN50265-2-



Highly Flexible



Low Toxicity
NES 02-713/NF C 20-454



Low Corrosivity
IEC60754-2
EN50267-2-2/3
NF C 32-074



Low Smoke Emission
IEC 61034-1&2
EN 50268-1&2/NF C32-073

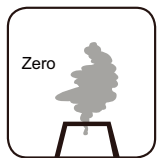

Halogen Free
IEC60754-1/
EN50267-2-1

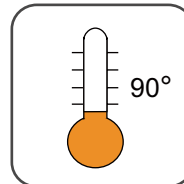

Operating Temperature

450/750V XLPE Insulated, LSZH Sheathed Power Cables (2-4core)

FTX200 07RZ1-R (CU/XLPE/LSZH 450/750V Class 2)

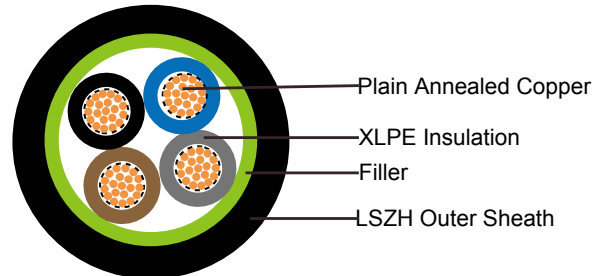
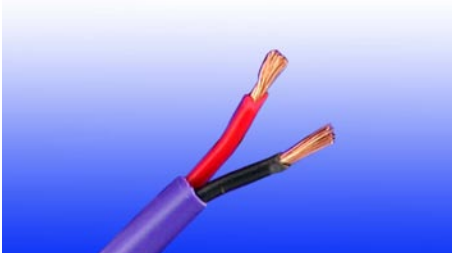

APPLICATION

The cables are mainly used in the conveyor belts, sensors, X rays, automatic sorters in the airport baggage handling system where high flexibility and heat resistance may be required. Ability to operate at high temperature protect this cables from premature aging due to constant exposure to ambient heat generated in the system, while LSZH properties assure low smoke and corrosive gas in the event of a fire.

STANDARDS

Basic design to BS 7211; IEC 60502-1

FIRE PERFORMANCE

Flame Retardance (Single Vertical Wire Test)	EN 60332-1-2; IEC 60332-1-2; BS EN 60332-1-2; VDE 0482-332-1 ; NBN C 30-004 (cat. F1); NF C32-070-2.1(C2); CEI 20-35/1-2; EN 50265-2-1*; DIN VDE 0482-265-2-1*
Reduced Fire Propagation (Vertically-mounted bundled wires & cable test)	EN 60332-3-24 (cat. C); IEC 60332-3-24; BS EN 60332-3-24; VDE 0482-332-3; NBN C 30-004 (cat. F2); NF C32-070-2.2(C1); CEI 20-22/3-4; EN 50266-2-4*; DIN VDE 0482-266-2-4
Halogen Free	IEC 60754-1; EN 50267-2-1; DIN VDE 0482-267-2-1; CEI 20-37/2-1 ; BS 6425-1*
No Corrosive Gas Emission	IEC 60754-2; EN 50267-2-2; DIN VDE 0482-267-2-2; CEI 20-37/2-2 ; BS 6425-2*
Minimum Smoke Emission	IEC 61034-1&2; EN 61034 -1&2; DIN VDE 0482-1034-1&2; CEI 20-37/3-1&2; EN 50268-1&2*; BS 7622-1&2*
No Toxic gases	NES 02-713; NF C 20-454

Note: Asterisk * denotes superseded standard.

VOLTAGE RATING

450/750V

CABLE CONSTRUCTION

Conductor: Plain annealed copper wire, stranded according to IEC(EN) 60228 class 2.

Insulation: Extruded cross-linked XLPE compound.

Filler, binder (if any): PP, PET



Outer Sheath: Thermoplastic LSZH compound type LTS3 as per BS 7655-6.1 (Thermosetting LSZH compound type SW2-SW4 as per BS 7655-2.6 can be offered.)

COLOUR CODE

Insulation Colour as per BS7671

	with earth conductor	without earth conductor
2Cores	-	Brown,Blue
3Cores	Yellow/Green,Brown,Blue	Brown,Gray,Black
4Cores	Yellow/Green,Brown,Gray,Black	Brown,Gray,Black,Blue
5Cores	Yellow/Green,Brown,Gray,Black,Blue	Brown,Gray,Black,Blue,Black
above 5 Cores	Yellow/Green,Black Numbered	Black Numbered

Sheath Colour: Black or as order.

PHYSICAL AND THERMAL PROPERTIES

Temperature range during operation: Max.90°C for XLPE
250°C in short-circuit for 5s max.

Minimum bending radius: 6 x Overall Diameter

CONSTRUCTION PARAMETERS

Conductor			FTX200 07RZ1-R				
No. of Core X Cross Section	No./Nominal Diameter of Strands	Nominal Overall Diameter Conductor	Nominal Insulation Thickness	Nominal Sheath Thickness	Nominal Overall Diameter	Max.DC resistance of conductor @20°C	Approx. Weight
Noxmm ²	No./mm	mm	mm	mm	mm	Ω/km	kg/km
2x1.0	7/0.44	1.32	0.7	1.2	8.5	18.1	101
2x1.5	7/0.53	1.59	0.7	1.2	9.1	12.1	120
2x2.5	7/0.67	2.01	0.7	1.2	10.0	7.41	154
2x4.0	7/0.85	2.55	0.7	1.3	11.1	4.61	205
3x1.0	7/0.44	1.32	0.7	1.2	9.0	18.1	118
3x1.5	7/0.53	1.59	0.7	1.2	9.6	12.1	142
3x2.5	7/0,67	2.01	0.7	1.2	10.6	7.41	185
3x4.0	7/0.85	2.55	0.7	1.3	11.8	4.61	251
4x1.0	7/0.44	1.32	0.7	1.2	9.8	18.1	141
4x1.5	7/0.53	1.59	0.7	1.2	10.5	12.1	171
4x2.5	7/0.67	2.01	0.7	1.3	11.6	7.41	226
4x4.0	7/0.85	2.55	0.7	1.3	13.0	4.61	309

ELECTRICAL PROPERTIES

Conductor Operating Temperature : 90°C

Ambient Temperature : 30°C

Current-Carrying Capacities (Amp)

Conductor cross-sectional area	Reference Method 4 (enclosed in conduit in thermally insulating wall etc)		Reference Method 3 (enclosed in conduit on a wall or in trunking etc)		Reference Method 1 (clipped direct)		Reference Method 11 (on a perforated cable tray, horizontal or vertical)		Reference Method 12 (free air)		
	2 cables, single-phase a.c. or d.c.	3 or 4 cables, 3-phase a.c.	2 cables, single-phase a.c. or d.c.	3 or 4 cables, 3-phase a.c.	2 cables, single-phase a.c. or d.c. flat and touching	3 or 4 cables, 3-phase a.c. flat and touching or trefoil	2 cables, single-phase a.c. or d.c. or flat and touching	3 or 4 cables, 3-phase a.c. flat and touching or trefoil	Horizontal flat spaced	Vertical flat spaced	Trefoil
1	2	3	4	5	6	7	8	9	10	11	12
mm ²	A	A	A	A	A	A	A	A	A	A	A
1.0	13	-	-	-	15	-	-	-	-	-	-
1.5	18	17	22	19	25	23	-	-	-	-	-
2.5	24	23	30	26	34	31	-	-	-	-	-
4	33	30	40	35	46	41	-	-	-	-	-

Voltage Drop (Per Amp Per Meter)

Nominal Cross Section Area	2 cables d.c.	2 cables, single-phase a.c.		3 or 4 cables, 3-phase a.c.		
		Ref. Methods 3 and 4 (enclosed in conduit etc, in or on a wall)	Ref. Methods 1 and 11 (clipped direct or on trays touching)	Ref. Methods 3 and 4 (enclosed in conduit etc, in or on a wall)	Ref. Methods 1, 11 and 12 (in trefoil)	Ref. Methods 1 and 11 (Flat and touching)
1	2	3	4	5	6	7
mm ²	mV/A/m	mV/A/m	mV/A/m	mV/A/m	mV/A/m	mV/A/m
1.0	46	46	-	-	-	-
1.5	31	31	27	27	27	27
2.5	19	19	16	16	16	16
4	33	12	10	10	10	10



Rated Voltage



Standard



Standard



Reduced Fire Propagation
NF C32-070-2.2(C1)
IEC60332-3-24
EN50266-2-4



Flame Retardancy
NF C32-070-2.1(C2)
IEC60332-1-2/EN50265-2-1

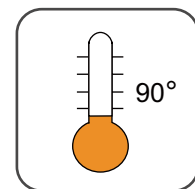

Operating Temperature



Low Toxicity
NES 02-713/NF C 20-454



Low Corrosivity
IEC60754-2
EN50267-2-2/3
NF C 32-074



Low Smoke Emission
IEC 61034-1&2
EN 50268-1&2/NF C32-073

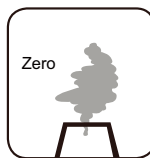

Halogen Free
IEC60754-1
EN50267-2-1



Highly Flexible



450/750V XLPE Insulated, LSZH Sheathed Power Cables (multicores)

FTX200 07RZ1-R (CU/XLPE/LSZH 450/750V Class 2)

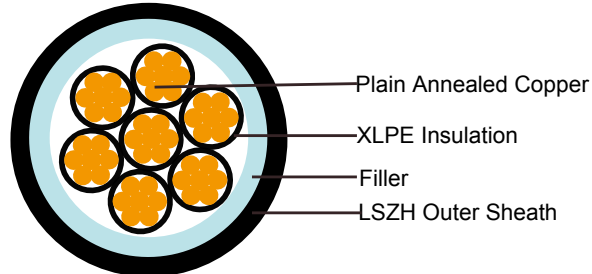

APPLICATION

The cables are mainly used in the conveyer belts, sensors, X rays, automatic sorters in the airport baggage handling system where high flexibility and heat resistance may be required. Ability to operate at high temperature protect this cables from premature aging due to constant exposure to ambient heat generated in the system, while LSZH properties assure low smoke and corrosive gas in the event of a fire.

STANDARDS

Basic design to BS 7211; IEC 60502-1

FIRE PERFORMANCE

Flame Retardance (Single Vertical Wire Test)	EN 60332-1-2; IEC 60332-1-2; BS EN 60332-1-2; VDE 0482-332-1 ; NBN C 30-004 (cat. F1); NF C32-070-2.1(C2); CEI 20-35/1-2; EN 50265-2-1*; DIN VDE 0482-265-2-1*
Reduced Fire Propagation (Vertically-mounted bundled wires & cable test)	EN 60332-3-24 (cat. C); IEC 60332-3-24; BS EN 60332-3-24; VDE 0482-332-3; NBN C 30-004 (cat. F2); NF C32-070-2.2(C1); CEI 20-22/3-4; EN 50266-2-4*; DIN VDE 0482-266-2-4
Halogen Free	IEC 60754-1; EN 50267-2-1; DIN VDE 0482-267-2-1; CEI 20-37/2-1 ; BS 6425-1*
No Corrosive Gas Emission	IEC 60754-2; EN 50267-2-2; DIN VDE 0482-267-2-2; CEI 20-37/2-2 ; BS 6425-2*
Minimum Smoke Emission	IEC 61034-1&2; EN 61034 -1&2; DIN VDE 0482-1034-1&2; CEI 20-37/3-1&2; EN 50268-1&2*; BS 7622-1&2*
No Toxic gases	NES 02-713; NF C 20-454

Note: Asterisk * denotes superseded standard.

VOLTAGE RATING

450/750V

CABLE CONSTRUCTION

Conductor: Plain annealed copper wire, stranded according to IEC(EN) 60228 class 2.

Insulation: Extruded cross-linked XLPE compound.

Filler, binder (if any): PP, PET

Outer Sheath: Thermoplastic LSZH compound type LTS3 as per BS 7655-6.1 (Thermosetting LSZH compound type SW2-SW4 as per BS 7655-2.6 can be offered.)

COLOUR CODE

Insulation Colour as per BS7671

	with earth conductor	without earth conductor
2Cores	-	Brown,Blue
3Cores	Yellow/Green,Brown,Blue	Brown,Gray,Black
4Cores	Yellow/Green,Brown,Gray,Black	Brown,Gray,Black,Blue
5Cores	Yellow/Green,Brown,Gray,Black,Blue	Brown,Gray,Black,Blue,Black
above 5 Cores	Yellow/Green,Black Numbered	Black Numbered

Sheath Colour: Black or as order.

PHYSICAL AND THERMAL PROPERTIES

Temperature range during operation: Max.90°C for XLPE
250°C in short-circuit for 5s max.

Minimum bending radius: 6 x Overall Diameter

CONSTRUCTION PARAMETERS

Conductor			FTX200 07RZ1-R				
No. of Core X Cross Section	No./Nominal Diameter of Strands	Nominal Overall Diameter Conductor	Nominal Insulation Thickness	Nominal Sheath Thickness	Nominal Overall Diameter	Max.DC resistance of conductor @20°C	Approx. Weight
Noxmm ²	No./mm	mm	mm	mm	mm	Ω/km	kg/km
7x1.0	7/0.44	1.32	0.7	1.3	11.6	18.1	210
7x1.5	7/0.53	1.59	0.7	1.3	12.5	12.1	258
7x2.5	7/0.67	2.01	0.7	1.3	13.8	7.41	347
12x1.5	7/0.53	1.59	0.7	1.4	16.5	12.1	413
12x2.5	7/0.67	2.01	0.7	1.5	18.3	7.41	561
19x1.5	7/0.53	1.59	0.7	1.5	19.3	12.1	609
19x2.5	7/0.67	2.01	0.7	1.6	21.6	7.41	836

ELECTRICAL PROPERTIES

Conductor Operating Temperature : 90°C

Ambient Temperature : 30°C

Current-Carrying Capacities (Amp)



Caledonian Flame Retardant Power & Control Cables

www.caledonian-cables.co.uk www.addison-cables.com



Conductor cross-sectional area	Reference Method 4 (enclosed in conduit in thermally insulating wall etc)		Reference Method 3 (enclosed in conduit on a wall or in trunking etc)		Reference Method 1 (clipped direct)		Reference Method 11 (on a perforated cable tray, horizontal or vertical)		Reference Method 12 (free air)			
	Horizontal flat spaced	Vertical flat spaced	Trefoil	Horizontal flat spaced	Vertical flat spaced	Trefoil	Horizontal flat spaced	Vertical flat spaced	Trefoil	Horizontal flat spaced	Vertical flat spaced	Trefoil
	2 cables, single-phase a.c. or d.c.	3 or 4 cables, 3-phase a.c.	2 cables, single-phase a.c. or d.c.	3 or 4 cables, 3-phase a.c.	2 cables, single-phase a.c. or d.c. flat and touching	3 or 4 cables, 3-phase a.c. flat and touching or trefoil	2 cables, single-phase a.c. or d.c. flat and touching	3 or 4 cables, 3-phase a.c. flat and touching or trefoil	2 cables, single-phase a.c. or d.c. or 3 cables three phase	2 cables, single-phase a.c. or d.c. or 3 cables three phase	3 cables, trefoil 3-phase a.c.	
1 mm ²	2	3	4	5	6	7	8	9	10	11	12	
1.0	13	-	-	-	15	-	-	-	-	-	-	-
1.5	18	17	22	19	25	23	-	-	-	-	-	-
2.5	24	23	30	26	34	31	-	-	-	-	-	-

Voltage Drop (Per Amp Per Meter)

Nominal Cross Section Area	2 cables d.c.	2 cables, single-phase a.c.		3 or 4 cables, 3-phase a.c.		
		Ref. Methods 3 and 4 (enclosed in conduit etc, in or on a wall)	Ref. Methods 1 and 11 (clipped direct or on trays touching)	Ref. Methods 3 and 4 (enclosed in conduit etc, in or on a wall)	Ref. Methods 1, 11 and 12 (in trefoil)	Ref. Methods 1 and 11 (Flat and touching)
1 mm ²	2	3	4	5	6	7
1.0	46	46	-	-	-	-
1.5	31	31	27	27	27	27
2.5	19	19	16	16	16	16



450/750V

Rated Voltage



BS 7211

Standard



IEC 60502-1

Standard



Reduced Fire Propagation
NF C32-070-2.2(C1)
IEC60332-3-24
EN50266-2-4



Flame Retardancy
NF C32-070-2.1(C2)
IEC60332-1-2/EN50265-2-1

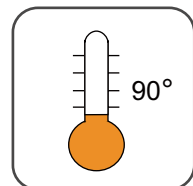

Operating Temperature



Low Toxicity
NES 02-713/NF C 20-454



Low Corrosivity
IEC60754-2
EN50267-2-2/3
NF C 32-074



Low Smoke Emission
IEC 61034-1&2
EN 50268-1&2/NF C32-073

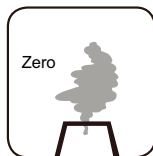

Zero
Halogen Free
IEC60754-1/
EN50267-2-1



Highly Flexible

450/750V XLPE Insulated, LSZH Sheathed, Screened Power Cables (2-4core)

FTX200 07RCZ1-R (CU/XLPE/CUTO/LSZH 450/750V Class 2)

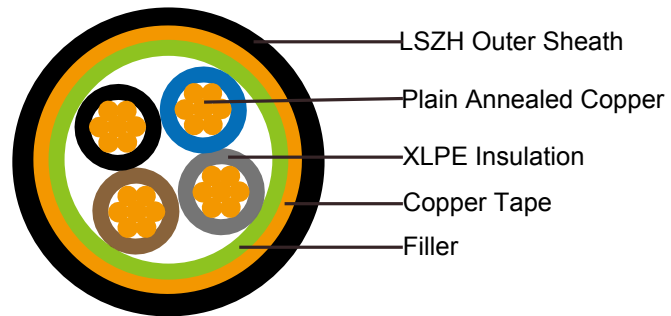

APPLICATION

The cables are mainly used in the conveyer belts, sensors, X rays, automatic sorters in the airport baggage handling system where high flexibility and heat resistance may be required. Ability to operate at high temperature protect this cables from premature aging due to constant exposure to ambient heat generated in the system, while LSZH properties assure low smoke and corrosive gas in the event of a fire.

STANDARDS

Basic design to BS 7211; IEC 60502-1

FIRE PERFORMANCE

Flame Retardance (Single Vertical Wire Test)	EN 60332-1-2; IEC 60332-1-2; BS EN 60332-1-2; VDE 0482-332-1 ; NBN C 30-004 (cat. F1); NF C32-070-2.1(C2); CEI 20-35/1-2; EN 50265-2-1*; DIN VDE 0482-265-2-1*
Reduced Fire Propagation (Vertically-mounted bundled wires & cable test)	EN 60332-3-24 (cat. C); IEC 60332-3-24; BS EN 60332-3-24; VDE 0482-332-3; NBN C 30-004 (cat. F2); NF C32-070-2.2(C1); CEI 20-22/3-4; EN 50266-2-4*; DIN VDE 0482-266-2-4
Halogen Free	IEC 60754-1; EN 50267-2-1; DIN VDE 0482-267-2-1; CEI 20-37/2-1 ; BS 6425-1*
No Corrosive Gas Emission	IEC 60754-2; EN 50267-2-2; DIN VDE 0482-267-2-2; CEI 20-37/2-2 ; BS 6425-2*
Minimum Smoke Emission	IEC 61034-1&2; EN 61034 -1&2; DIN VDE 0482-1034-1&2; CEI 20-37/3-1&2; EN 50268-1&2*; BS 7622-1&2*
No Toxic gases	NES 02-713; NF C 20-454

Note: Asterisk * denotes superseded standard.

VOLTAGE RATING



450/750V

CABLE CONSTRUCTION

Conductor: Plain annealed copper wire, stranded according to IEC(EN) 60228 class 2.

Insulation: Extruded cross-linked XLPE compound.

Filler, binder (if any): PP, PET, LSZH

Overall Screen: Copper tape

Outer Sheath: Thermoplastic LSZH compound type LTS3 as per BS 7655-6.1 (Thermosetting LSZH compound type SW2-SW4 as per BS 7655-2.6 can be offered.)

COLOUR CODE

Insulation Colour as per BS7671

	with earth conductor	without earth conductor
2Cores	-	Brown,Blue
3Cores	Yellow/Green,Brown,Blue	Brown,Gray,Black
4Cores	Yellow/Green,Brown,Gray,Black	Brown,Gray,Black,Blue
5Cores	Yellow/Green,Brown,Gray,Black,Blue	Brown,Gray,Black,Blue,Black
above 5 Cores	Yellow/Green,Black Numbered	Black Numbered

Sheath Colour: Black or as order.

PHYSICAL AND THERMAL PROPERTIES

Temperature range during operation: Max.90°C for XLPE
250°C in short-circuit for 5s max.

Minimum bending radius: 8 x Overall Diameter

CONSTRUCTION PARAMETERS

Conductor			FTX200 07RCZ1-R					
No. of Core X Cross Section	No./ Nominal Diameter of Strands	Nominal Overall Diameter Conductor	Nominal Insulation Thickness	Nominal Copper Tape Thickness	Nominal Sheath Thickness	Nominal Overall Diameter	Max.DC resistance of conductor @20°C	Approx. Weight
Noxmm ²	No./mm	mm	mm	mm	mm	mm	Ω/km	kg/km
2x1.0	7/0.44	1.32	0.7	0.1	1.2	10.7	18.1	172
2x1.5	7/0.53	1.59	0.7	0.1	1.3	11.3	12.1	197
2x2.5	7/0.67	2.01	0.7	0.1	1.3	12.2	7.41	239
2x4.0	7/0.85	2.55	0.7	0.1	1.3	13.4	4.61	300
3x1.0	7/0.44	1.32	0.7	0.1	1.3	11.2	18.1	194
3x1.5	7/0.53	1.59	0.7	0.1	1.3	11.8	12.1	224
3x2.5	7/0,67	2.01	0.7	0.1	1.3	12.8	7.41	276
3x4.0	7/0.85	2.55	0.7	0.1	1.3	14.1	4.61	353

4x1.0	7/0.44	1.32	0.7	0.1	1.3	12.0	18.1	224
4x1.5	7/0.53	1.59	0.7	0.1	1.4	12.7	12.1	261
4x2.5	7/0.67	2.01	0.7	0.1	1.3	13.9	7.41	326
4x4.0	7/0.85	2.55	0.7	0.1	1.3	15.3	4.61	422

ELECTRICAL PROPERTIES

Conductor Operating Temperature : 90°C

Ambient Temperature : 30°C

Current-Carrying Capacities (Amp)

Conductor cross-sectional area	Reference Method 4 (enclosed in conduit in thermally insulating wall etc)		Reference Method 3 (enclosed in conduit on a wall or in trunking etc)		Reference Method 1 (clipped direct)		Reference Method 11 (on a perforated cable tray, horizontal or vertical)		Reference Method 12 (free air)		
	Horizontal flat spaced	Vertical flat spaced	Trefoil	Horizontal flat spaced	Vertical flat spaced	Trefoil	Horizontal flat spaced	Vertical flat spaced	Trefoil		
	2 cables, single-phase a.c. or d.c.	3 or 4 cables, 3-phase a.c.	2 cables, single-phase a.c. or d.c.	3 or 4 cables, 3-phase a.c.	2 cables, single-phase a.c. or d.c. flat and touching	3 or 4 cables, 3-phase a.c. flat and touching or trefoil	2 cables, single-phase a.c. or d.c. flat and touching	3 or 4 cables, 3-phase a.c. flat and touching or trefoil	2 cables, single-phase a.c. or d.c. or 3 cables three phase	2 cables, single-phase a.c. or d.c. or 3 cables three phase	3 cables, trefoil 3-phase a.c.
1	2	3	4	5	6	7	8	9	10	11	12
mm ²	A	A	A	A	A	A	A	A	A	A	A
1.0	13	-	-	-	15	-	-	-	-	-	-
1.5	18	17	22	19	25	23	-	-	-	-	-
2.5	24	23	30	26	34	31	-	-	-	-	-
4	33	30	40	35	46	41	-	-	-	-	-



Voltage Drop (Per Amp Per Meter)

Nominal Cross Section Area	2 cables d.c.	2 cables, single-phase a.c.		3 or 4 cables, 3-phase a.c.		
		Ref. Methods 3 and 4 (enclosed in conduit etc, in or on a wall)	Ref. Methods 1 and 11 (clipped direct or on trays touching)	Ref. Methods 3 and 4 (enclosed in conduit etc, in or on a wall)	Ref. Methods 1, 11 and 12 (in trefoil)	Ref. Methods 1 and 11 (Flat and touching)
1	2	3	4	5	6	7
mm ²	mV/A/m	mV/A/m	mV/A/m	mV/A/m	mV/A/m	mV/A/m
1.0	46	46	-	-	-	-
1.5	31	31	27	27	27	27
2.5	19	19	16	16	16	16
4	33	12	10	10	10	10



450/750V

Rated Voltage



BS 7211

Standard



IEC60502-1

Standard



Reduced Fire Propagation
NF C32-070-2.2(C1)
IEC60332-3-24
EN50266-2-4



Flame Retardancy
NF C32-070-2.1(C2)
IEC60332-1-2/EN50265-2-1

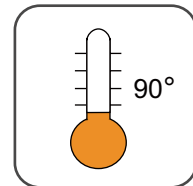

Operating Temperature



Low Toxicity
NES 02-713/NF C 20-454



Low Corrosivity
IEC60754-2
EN50267-2-2/3
NF C 32-074



Low Smoke Emission
IEC 61034-1&2
EN 50268-1&2/NF C32-073

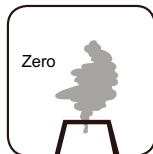

Halogen Free
IEC60754-1/
EN50267-2-1



Highly Flexible

450/750V XLPE Insulated, LSZH Sheathed, Screened Power Cables (multicore)

FTX200 07RCZ1-R (CU/XLPE/CUTO/LSZH 450/750V Class 2)

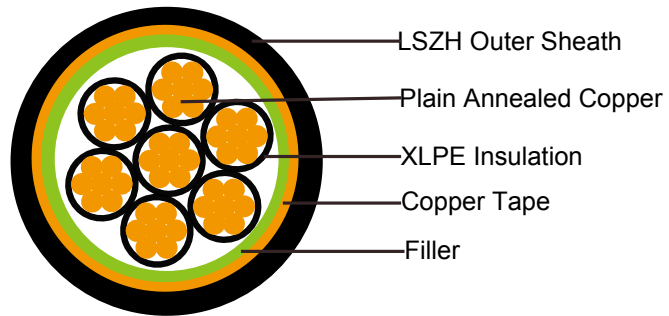

APPLICATION

The cables are mainly used in the conveyer belts, sensors, X rays, automatic sorters in the airport baggage handling system where high flexibility and heat resistance may be required. Ability to operate at high temperature protect this cables from premature aging due to constant exposure to ambient heat generated in the system, while LSZH properties assure low smoke and corrosive gas in the event of a fire.

STANDARDS

Basic design to BS 7211; IEC 60502-1

FIRE PERFORMANCE

Flame Retardance (Single Vertical Wire Test)	EN 60332-1-2; IEC 60332-1-2; BS EN 60332-1-2; VDE 0482-332-1 ; NBN C 30-004 (cat. F1); NF C32-070-2.1(C2); CEI 20-35/1-2; EN 50265-2-1*; DIN VDE 0482-265-2-1*
Reduced Fire Propagation (Vertically-mounted bundled wires & cable test)	EN 60332-3-24 (cat. C); IEC 60332-3-24; BS EN 60332-3-24; VDE 0482-332-3; NBN C 30-004 (cat. F2); NF C32-070-2.2(C1); CEI 20-22/3-4; EN 50266-2-4*; DIN VDE 0482-266-2-4
Halogen Free	IEC 60754-1; EN 50267-2-1; DIN VDE 0482-267-2-1; CEI 20-37/2-1 ; BS 6425-1*
No Corrosive Gas Emission	IEC 60754-2; EN 50267-2-2; DIN VDE 0482-267-2-2; CEI 20-37/2-2 ; BS 6425-2*
Minimum Smoke Emission	IEC 61034-1&2; EN 61034 -1&2; DIN VDE 0482-1034-1&2; CEI 20-37/3-1&2; EN 50268-1&2*; BS 7622-1&2*
No Toxic gases	NES 02-713; NF C 20-454

Note: Asterisk * denotes superseded standard.

VOLTAGE RATING



450/750V

CABLE CONSTRUCTION

Conductor: Plain annealed copper wire, stranded according to IEC(EN) 60228 class 2.

Insulation: Extruded cross-linked XLPE compound.

Filler, binder (if any): PP, PET, LSZH

Overall Screen: Copper tape

Outer Sheath: Thermoplastic LSZH compound type LTS3 as per BS 7655-6.1 (Thermosetting LSZH compound type SW2-SW4 as per BS 7655-2.6 can be offered.)

COLOUR CODE

Insulation Colour as per BS7671

	with earth conductor	without earth conductor
2Cores	-	Brown,Blue
3Cores	Yellow/Green,Brown,Blue	Brown,Gray,Black
4Cores	Yellow/Green,Brown,Gray,Black	Brown,Gray,Black,Blue
5Cores	Yellow/Green,Brown,Gray,Black,Blue	Brown,Gray,Black,Blue,Black
above 5 Cores	Yellow/Green,Black Numbered	Black Numbered

Sheath Colour: Black or as order.

PHYSICAL AND THERMAL PROPERTIES

Temperature range during operation: Max.90°C for XLPE
250°C in short-circuit for 5s max.

Minimum bending radius: 8 x Overall Diameter

CONSTRUCTION PARAMETERS

Conductor			FTX200 07RCZ1-R					
No. of Core X Cross Section	No./Nominal Diameter of Strands	Nominal Overall Diameter Conductor	Nominal Insulation Thickness	Nominal Copper Tape Thickness	Nominal Sheath Thickness	Nominal Overall Diameter	Max.DC resistance of conductor @20°C	Approx. Weight
Noxmm ²	No./mm	mm	mm	mm	mm	mm	Ω/km	kg/km
7x1.0	7/0.44	1.32	0.7	0.1	1.3	13.9	18.1	309
7x1.5	7/0.53	1.59	0.7	0.1	1.4	14.8	12.1	366
7x2.5	7/0.44	2.01	0.7	0.1	1.4	16.2	7.41	468
12x1.5	7/0.53	1.59	0.7	0.1	1.5	18.9	12.1	560
12x2.5	7/0.67	2.01	0.7	0.1	1.5	20.8	7.41	727
19x1.5	7/0.53	1.59	0.7	0.1	1.6	21.9	12.1	786
19x2.5	7/0.67	2.01	0.7	0.1	1.6	24.2	7.41	1,037

ELECTRICAL PROPERTIES

Conductor Operating Temperature : 90°C

Ambient Temperature : 30°C

Current-Carrying Capacities (Amp)

Conductor cross-sectional area	Reference Method 4 (enclosed in conduit in thermally insulating wall etc)		Reference Method 3 (enclosed in conduit on a wall or in trunking etc)		Reference Method 1 (clipped direct)		Reference Method 11 (on a perforated cable tray, horizontal or vertical)		Reference Method 12 (free air)		
	2 cables, single-phase a.c. or d.c.	3 or 4 cables, 3-phase a.c.	2 cables, single-phase a.c. or d.c.	3 or 4 cables, 3-phase a.c.	2 cables, single-phase a.c. or d.c. flat and touching	3 or 4 cables, 3-phase a.c. flat and touching or trefoil	2 cables, single-phase a.c. or d.c. or flat and touching	3 or 4 cables, 3-phase a.c. flat and touching or trefoil	Horizontal flat spaced	Vertical flat spaced	Trefoil
	2	3	4	5	6	7	8	9	10	11	12
mm ²	A	A	A	A	A	A	A	A	A	A	A
1.0	13	-	-	-	15	-	-	-	-	-	-
1.5	18	17	22	19	25	23	-	-	-	-	-
2.5	24	23	30	26	34	31	-	-	-	-	-
4	33	30	40	35	46	41	-	-	-	-	-



Voltage Drop (Per Amp Per Meter)

Nominal Cross Section Area	2 cables d.c.	2 cables, single-phase a.c.		3 or 4 cables, 3-phase a.c.		
		Ref. Methods 3 and 4 (enclosed in conduit etc, in or on a wall)	Ref. Methods 1 and 11 (clipped direct or on trays touching)	Ref. Methods 3 and 4 (enclosed in conduit etc, in or on a wall)	Ref. Methods 1,	Ref. Methods 1 and 11
					11 and 12 (in trefoil)	
1	2	3	4	5	6	7
mm ²	mV/A/m	mV/A/m	mV/A/m	mV/A/m	mV/A/m	mV/A/m
1.0	46	46	-	-	-	-
1.5	31	31	27	27	27	27
2.5	19	19	16	16	16	16
4	33	12	10	10	10	10



450/750V

Rated Voltage



BS 7211

Standard



IEC60502-1

Standard



Reduced Fire Propagation
NF C32-070-2.2(C1)
IEC60332-3-24
EN50266-2-4



Flame Retardancy
NF C32-070-2.1(C2)
IEC60332-1-2/EN50265-2-1

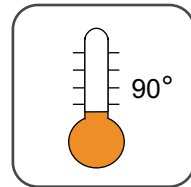

Operating Temperature



Low Toxicity
NES 02-713/NF C 20-454



Low Corrosivity
IEC60754-2
EN50267-2-2/3
NF C 32-074



Low Smoke Emission
IEC 61034-1&2
EN 50268-1&2/NF C32-073

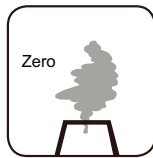

Zero
Halogen Free
IEC60754-1/
EN50267-2-1



Highly Flexible

600/1000V LSZH Insulated, Non-sheathed Power Cables (single core)

FTX300 1Z1-R (CU/LSZH 600/1000V Class 2)

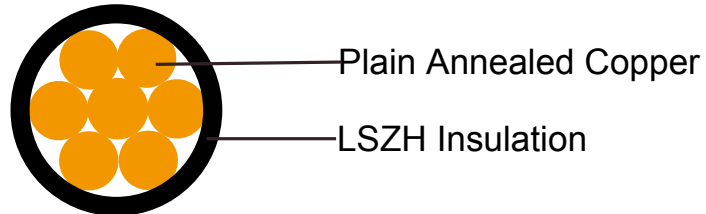
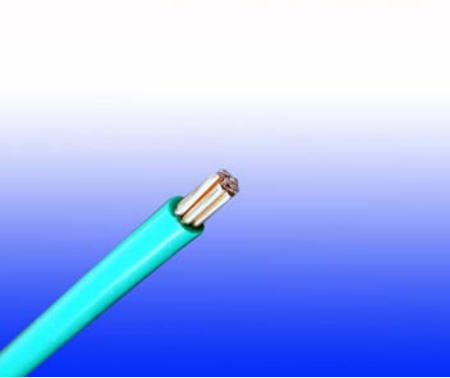

APPLICATION

The cables are mainly used in the conveyer belts, sensors, X rays, automatic sorters in the airport baggage handling system where high flexibility and heat resistance may be required. Ability to operate at high temperature protect this cables from premature aging due to constant exposure to ambient heat generated in the system, while LSZH properties assure low smoke and corrosive gas in the event of a fire.

STANDARDS

Basic design to BS 7211

FIRE PERFORMANCE

Flame Retardance (Single Vertical Wire Test)	EN 60332-1-2; IEC 60332-1-2; BS EN 60332-1-2; VDE 0482-332-1 ; NBN C 30-004 (cat. F1); NF C32-070-2.1(C2); CEI 20-35/1-2; EN 50265-2-1*; DIN VDE 0482-265-2-1*
Reduced Fire Propagation (Vertically-mounted bundled wires & cable test)	EN 60332-3-24 (cat. C); IEC 60332-3-24; BS EN 60332-3-24; VDE 0482-332-3; NBN C 30-004 (cat. F2); NF C32-070-2.2(C1); CEI 20-22/3-4; EN 50266-2-4*; DIN VDE 0482-266-2-4
Halogen Free	IEC 60754-1; EN 50267-2-1; DIN VDE 0482-267-2-1; CEI 20-37/2-1 ; BS 6425-1*
No Corrosive Gas Emission	IEC 60754-2; EN 50267-2-2; DIN VDE 0482-267-2-2; CEI 20-37/2-2 ; BS 6425-2*
Minimum Smoke Emission	IEC 61034-1&2; EN 61034 -1&2; DIN VDE 0482-1034-1&2; CEI 20-37/3-1&2; EN 50268-1&2*; BS 7622-1&2*
No Toxic gases	NES 02-713; NF C 20-454

Note: Asterisk * denotes superseded standard.



VOLTAGE RATING

600/1000V

CABLE CONSTRUCTION

Conductor: Plain annealed copper wire, stranded according to IEC(EN) 60228 class 2.

Insulation: Extruded cross-linked XLPE compound.

COLOUR CODE

Insulation Colour as per Bs 7671: Natural

Sheath Colour: Black or as order.

PHYSICAL AND THERMAL PROPERTIES

Temperature range during operation: Max.90°C
250°C in short-circuit for 5s max.

Minimum bending radius: 8 x Overall Diameter (unarmoured cable)
10 x Overall Diameter (armoured cable)

CONSTRUCTION PARAMETERS

Conductor		FTX300 1Z1-R		
No. of Core X Cross Section	No./Nominal Diameter of Strands	Nominal Insulation Thickness	Insulated, Non-Sheathed	
			Nominal Overall Diameter	Approx. Weight
Noxmm ²	No./mm	mm	mm	kg/km
1x1.5	7/0.53	0.7	3.1	22
1x2.5	7/0.67	0.8	3.7	34
1x4	7/0.85	0.8	4.3	50
1x6	7/1.04	0.8	4.8	70
1x10	7/1.35	1.0	6.2	116
1x16	7/1.70	1.0	7.2	174
1x25	7/2.14	1.2	9.0	276
1x35	7/2.52	1.2	10.0	366
1x50	19/1.78	1.4	11.9	502
1x70	19/2.14	1.4	13.7	706
1x95	19/2.52	1.6	16.0	974
1x120	37/2.03	1.6	17.6	1213
1x150	37/2.25	1.8	19.6	1492
1x185	37/2.52	2.0	21.8	1868
1x240	61/2.25	2.2	24.4	2443
1x300	61/2.52	2.4	27.7	3055

1x400	61/2.85	2.6	31.1	3888
1x500	61/3.20	2.8	34.6	4880
1x630	127/2.52	2.8	38.6	6229

ELECTRICAL PROPERTIES

Conductor Operating Temperature : 90°C

Ambient Temperature : 30°C

Current-Carrying Capacities (Amp)

Conductor cross-sectional area	Reference Method 4 (enclosed in conduit in thermally insulating wall etc)		Reference Method 3 (enclosed in conduit on a wall or in trunking etc)		Reference Method 1 (clipped direct)		Reference Method 11 (on a perforated cable tray, horizontal or vertical)		Reference Method 12 (free air)		
									Horizontal flat spaced	Vertical flat spaced	Trefoil
	2 cables, single-phase a.c. or d.c.	3 or 4 cables, 3-phase a.c.	2 cables, single-phase a.c. or d.c.	3 or 4 cables, 3-phase a.c.	2 cables, single-phase a.c. or d.c. flat and touching	3 or 4 cables, 3-phase a.c. flat and touching or trefoil	2 cables, single-phase a.c. or d.c. flat and touching	3 or 4 cables, 3-phase a.c. flat and touching or trefoil	2 cables, single-phase a.c. or d.c. or 3 cables three phase	2 cables, single-phase a.c. or d.c. or 3 cables three phase	3 cables, trefoil 3-phase a.c.
1	2	3	4	5	6	7	8	9	10	11	12
mm ²	A	A	A	A	A	A	A	A	A	A	A
1.5	18	17	22	19	25	23	-	-	-	-	-
2.5	24	23	30	26	34	31	-	-	-	-	-
4	33	30	40	35	46	41	-	-	-	-	-
6	43	39	51	45	59	54	-	-	-	-	-
10	58	53	71	63	81	74	-	-	-	-	-
16	76	70	95	85	109	99	-	-	-	-	-
25	100	91	126	111	143	130	158	140	183	163	138
35	125	111	156	138	176	161	195	176	226	203	171
50	149	135	189	168	228	209	293	215	274	246	209
70	189	170	240	214	293	268	308	279	351	318	270
95	228	205	290	259	355	326	375	341	426	389	330



120	263	235	336	299	413	379	436	398	495	453	385
150	300	270	375	328	476	436	505	461	570	524	445
185	341	306	426	370	545	500	579	530	651	600	511
240	400	358	500	433	644	590	686	630	769	711	606
300	459	410	573	493	743	681	794	730	886	824	701
400	-	-	684	584	868	793	915	849	1065	994	820
500	-	-	783	666	990	904	1044	973	1228	1150	936
630	-	-	900	764	1130	1033	1191	1115	1423	1338	1069

Voltage Drop (Per Amp Per Meter)

Size of conductor	2 cables d.c.	2 cables, single-phase a.c.						3 or 4 cables, 3-phase a.c.								
		Ref. Methods 3 and 4 (enclosed in conduit etc, in or on a wall)			Ref. Methods 1 and 11 (clipped direct or on trays touching)			Ref. Methods 3 and 4 (enclosed in conduit etc, in or on a wall)			Ref. Methods 1, 11 and 12 (in trefoil)			Ref. Methods 1 and 11 (Flat and touching)		
1	2	3			4			5			6			7		
mm ²	mV/A/m	mV/A/m			mV/A/m			mV/A/m			mV/A/m			mV/A/m		
1.5	31	31			27			27			27			27		
2.5	19	19			16			16			16			16		
4	33	12			10			10			10			10		
6	7.8	7.9			6.8			6.8			6.8			6.8		
10	4.7	4.7			4.7			4			4			4		
16	2.9	2.9			2.9			2.5			2.5			2.5		
		r	x	z	r	x	z	r	x	z	r	x	z	r	x	z
25	1.85	1.85	0.31	1.90	1.85	0.190	1.85	1.60	0.27	1.65	1.600	0.165	1.600	1.600	0.190	1.600
35	1.35	1.35	0.29	1.35	1.35	0.180	1.35	1.15	0.25	1.15	1.150	0.155	1.50	1.150	0.180	1.150
50	0.99	1.00	0.29	1.05	0.99	0.180	1.00	0.87	0.25	0.90	0.860	0.155	0.870	0.860	0.180	0.870
70	0.68	0.70	0.28	0.75	0.68	0.175	0.71	0.60	0.24	0.65	0.590	0.150	0.610	0.590	0.175	0.620
95	0.49	0.51	0.27	0.58	0.49	0.170	0.52	0.44	0.23	0.50	0.430	0.145	0.450	0.430	0.170	0.460

120	0.39	0.41	0.26	0.48	0.39	0.165	0.43	0.35	0.23	0.42	0.340	0.140	0.370	0.340	0.165	0.380
150	0.32	0.33	0.26	0.43	0.32	0.165	0.36	0.29	0.23	0.37	0.280	0.140	0.310	0.280	0.165	0.320
185	0.25	0.27	0.26	0.37	0.26	0.165	0.30	0.23	0.23	0.32	0.220	0.140	0.260	0.220	0.165	0.280
240	0.19	0.21	0.26	0.33	0.20	0.160	0.25	0.185	0.22	0.29	0.170	0.140	0.220	0.170	0.165	0.240
300	0.155	0.175	0.25	0.31	0.16	0.160	0.22	0.150	0.22	0.27	0.140	0.140	0.195	0.135	0.160	0.210
400	0.12	0.140	0.25	0.29	0.13	0.155	0.20	0.125	0.22	0.25	0.110	0.135	0.175	0.110	0.160	0.195
500	0.093	0.120	0.25	0.28	0.105	0.155	0.185	0.100	0.22	0.24	0.090	0.135	0.160	0.088	0.160	0.180
630	0.072	0.100	0.25	0.27	0.086	0.155	0.175	0.088	0.21	0.23	0.074	0.135	0.150	0.071	0.160	0.170

Note :

r = conductor resistance at operating temperature

x = reactance

z = impedance



Rated Voltage



Standard



Reduced Fire Propagation
NF C32-070-2.2(C1)
IEC60332-3-24/EN50266-2-4



Flame Retardancy
NF C32-070-2.1(C2)
IEC60332-1-2/EN50265-2-1



Highly Flexible



Low Toxicity
NES 02-713/NF C 20-454



Low Corrosivity
IEC60754-2
EN50267-2-2/3
NF C 32-074



Low Smoke Emission
IEC 61034-1&2
EN 50268-1&2/NF C32-073

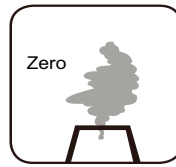

Halogen Free
IEC60754-1
EN50267-2-1

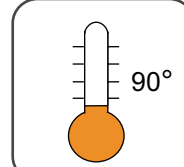

Operating Temperature



600/1000V XLPE Insulated, LSZH Sheathed, Armoured Power Cables (single core)

FTX300 1RZ1-R (CU/XLPE/LSZH 600/1000V Class 2)

FTX300 1RZ1MZ1-R (CU/XLPE/LSZH/AWA/LSZH 600/1000V Class 2)

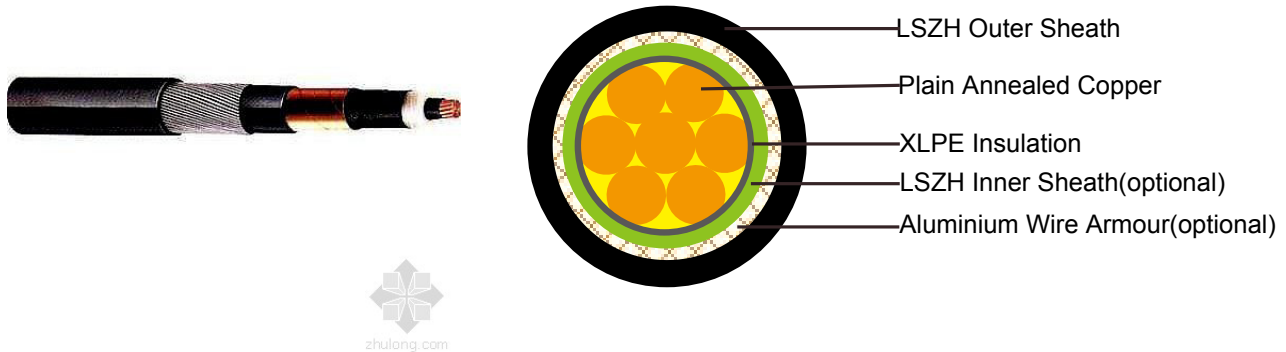

APPLICATION

The cables are mainly used in the conveyer belts, sensors, X rays, automatic sorters in the airport baggage handling system where high flexibility and heat resistance may be required. Ability to operate at high temperature protect this cables from premature aging due to constant exposure to ambient heat generated in the system, while LSZH properties assure low smoke and corrosive gas in the event of a fire.

STANDARDS

Basic design to IEC 60502-1; BS 6724; BS 7211

FIRE PERFORMANCE

Flame Retardance (Single Vertical Wire Test)	EN 60332-1-2; IEC 60332-1-2; BS EN 60332-1-2; VDE 0482-332-1 ; NBN C 30-004 (cat. F1); NF C32-070-2.1(C2); CEI 20-35/1-2; EN 50265-2-1*; DIN VDE 0482-265-2-1*
Reduced Fire Propagation (Vertically-mounted bundled wires & cable test)	EN 60332-3-24 (cat. C); IEC 60332-3-24; BS EN 60332-3-24; VDE 0482-332-3; NBN C 30-004 (cat. F2); NF C32-070-2.2(C1); CEI 20-22/3-4; EN 50266-2-4*; DIN VDE 0482-266-2-4
Halogen Free	IEC 60754-1; EN 50267-2-1; DIN VDE 0482-267-2-1; CEI 20-37/2-1 ; BS 6425-1*
No Corrosive Gas Emission	IEC 60754-2; EN 50267-2-2; DIN VDE 0482-267-2-2; CEI 20-37/2-2 ; BS 6425-2*
Minimum Smoke Emission	IEC 61034-1&2; EN 61034 -1&2; DIN VDE 0482-1034-1&2; CEI 20-37/3-1&2; EN 50268-1&2*; BS 7622-1&2*
No Toxic gases	NES 02-713; NF C 20-454

Note: Asterisk * denotes superseded standard.

VOLTAGE RATING

600/1000V

CABLE CONSTRUCTION

Conductor: Plain annealed copper wire, stranded according to IEC(EN) 60228 class 2.

Insulation: Extruded cross-linked XLPE compound.

Inner sheath(optional): LSZH Compound

Armouring(optional): Aluminium Wire

Outer Sheath: Thermoplastic LSZH compound type LTS3 as per BS 7655-6.1 (Thermosetting LSZH compound type SW2-SW4 as per BS 7655-2.6 can be offered.)

COLOUR CODE

Insulation Colour as per BS 7671 : Natural

Outer Sheath: Black or as order.

PHYSICAL AND THERMAL PROPERTIES

Temperature range during operation: Max.90°C
250°C in short-circuit for 5s max.

Minimum bending radius: 8 x Overall Diameter (unarmoured cable)
10 x Overall Diameter (armoured cable)

CONSTRUCTION PARAMETERS

Conductor		FTX300 1RZ1-R			FTX300 1RZ1MZ1-R			
No. of Core X Cross Section	No./ Nominal Diameter of Strands	Nominal Insulation Thickness	Unarmoured		Armoured			
			Nominal Overall Diameter	Approx. Weight	Diameter Under Armour	Armour Wire Diameter	Nominal Overall Diameter	Approx. Weight
mm ²	No./mm	mm	mm	kg/km	mm	mm	mm	kg/km
1x1.5	7/0.53	0.7	6	48	—	—	—	—
1x2.5	7/0.67	0.7	6.4	63	—	—	—	—
1x4	7/0.85	0.7	7.0	78	—	—	—	—
1x6	7/1.04	0.7	7.5	105	—	—	—	—
1x10	7/1.35	0.7	8.5	151	—	—	—	—
1x16	7/1.70	0.7	9.5	211	—	—	—	—
1x25	7/2.14	0.9	11.2	315	—	—	—	—
1x35	7/2.52	0.9	12.4	416	—	—	—	—
1x50	19/1.78	1.0	14	569	—	—	—	—
1x70	19/2.14	1.1	16	792	15.4	1.25	21.5	960
1x95	19/2.52	1.1	18	1068	17.3	1.25	23.4	1240
1x120	37/2.03	1.2	20	1325	19.1	1.6	25.9	1650
1x150	37/2.25	1.4	22	1627	21.1	1.6	27.9	1970



1x185	37/2.52	1.6	24.4	2021	23.2	1.6	30.1	2390
1x240	61/2.25	1.7	27.5	2617	26.2	1.6	33.2	3040
1x300	61/2.52	1.8	30.3	3252	28.8	1.6	35.8	3790
1x400	61/2.85	2.0	33.9	4131	32.7	2.0	40.9	4790
1x500	61/3.20	2.2	37.6	5175	36.2	2.0	44.6	5880
1x630	127/2.52	2.4	42.4	6631	40.6	2.0	49.2	7400
1x800	127/2.85	2.6	47.3	8412	45.7	2.5	55.7	9500
1x1000	127/3.20	2.8	52.4	10530	50.6	2.5	61.0	11750

ELECTRICAL PROPERTIES

Conductor Operating Temperature : 90°C

Ambient Temperature : 30°C

FTX300 1RZ1-R

Current-Carrying Capacities (Amp)

Conductor cross-sectional area	Reference Method 4 (enclosed in conduit in thermally insulating wall etc)		Reference Method 3 (enclosed in conduit on a wall or in trunking etc)		Reference Method 1 (clipped direct)		Reference Method 11 (on a perforated cable tray, horizontal or vertical)		Reference Method 12 (free air)		
	2 cables, single-phase a.c. or d.c.	3 or 4 cables, 3-phase a.c.	2 cables, single-phase a.c. or d.c.	3 or 4 cables, 3-phase a.c.	2 cables, single-phase a.c. or d.c. flat and touching	3 or 4 cables, 3-phase a.c. flat and touching or trefoil	2 cables, single-phase a.c. or d.c. flat and touching	3 or 4 cables, 3-phase a.c. flat and touching or trefoil	Horizontal flat spaced	Vertical flat spaced	Trefoil
1	2	3	4	5	6	7	8	9	10	11	12
mm ²	A	A	A	A	A	A	A	A	A	A	A
1.5	18	17	22	19	25	23	-	-	-	-	-
2.5	24	23	30	26	34	31	-	-	-	-	-
4	33	30	40	35	46	41	-	-	-	-	-
6	43	39	51	45	59	54	-	-	-	-	-
10	58	53	71	63	81	74	-	-	-	-	-
16	76	70	95	85	109	99	-	-	-	-	-
25	100	91	126	111	143	130	158	140	183	163	138
35	125	111	156	138	176	161	195	176	226	203	171
50	149	135	189	168	228	209	293	215	274	246	209

70	189	170	240	214	293	268	308	279	351	318	270
95	228	205	290	259	355	326	375	341	426	389	330
120	263	235	336	299	413	379	436	398	495	453	385
150	300	270	375	328	476	436	505	461	570	524	445
185	341	306	426	370	545	500	579	530	651	600	511
240	400	358	500	433	644	590	686	630	769	711	606
300	459	410	573	493	743	681	794	730	886	824	701
400	-	-	684	584	868	793	915	849	1065	994	820
500	-	-	783	666	990	904	1044	973	1228	1150	936
630	-	-	900	764	1130	1033	1191	1115	1423	1338	1069
800	-	-	-	-	1288	1179	1358	1275	1580	1485	1214
1000	-	-	-	-	1443	1323	1520	1436	1775	1671	1349

Voltage Drop (Per Amp Per Meter)

Size of conductor	2 cables d.c.	2 cables, single-phase a.c.						3 or 4 cables, 3-phase a.c.								
		Ref. Methods 3 and 4 (enclosed in conduit etc, in or on a wall)			Ref. Methods 1 and 11 (clipped direct or on trays touching)			Ref. Methods 3 and 4 (enclosed in conduit etc, in or on a wall)			Ref. Methods 1, 11 and 12 (in trefoil)			Ref. Methods 1 and 11 (Flat and touching)		
1	2	3			4			5			6			7		
mm ²	mV/A/m	mV/A/m			mV/A/m			mV/A/m			mV/A/m			mV/A/m		
1.5	31	31			27			27			27			27		
2.5	19	19			16			16			16			16		
4	33	12			10			10			10			10		
6	7.8	7.9			6.8			6.8			6.8			6.8		
10	4.7	4.7			4.7			4			4			4		
16	2.9	2.9			2.9			2.5			2.5			2.5		
		r	x	z	r	x	z	r	x	z	r	x	z	r	x	z
25	1.85	1.85	0.31	1.90	1.85	0.190	1.85	1.60	0.27	1.65	1.600	0.165	1.600	1.600	0.190	1.600
35	1.35	1.35	0.29	1.35	1.35	0.180	1.35	1.15	0.25	1.15	1.150	0.155	1.50	1.150	0.180	1.150
50	0.99	1.00	0.29	1.05	0.99	0.180	1.00	0.87	0.25	0.90	0.860	0.155	0.870	0.860	0.180	0.870
70	0.68	0.70	0.28	0.75	0.68	0.175	0.71	0.60	0.24	0.65	0.590	0.150	0.610	0.590	0.175	0.620
95	0.49	0.51	0.27	0.58	0.49	0.170	0.52	0.44	0.23	0.50	0.430	0.145	0.450	0.430	0.170	0.460
120	0.39	0.41	0.26	0.48	0.39	0.165	0.43	0.35	0.23	0.42	0.340	0.140	0.370	0.340	0.165	0.380
150	0.32	0.33	0.26	0.43	0.32	0.165	0.36	0.29	0.23	0.37	0.280	0.140	0.310	0.280	0.165	0.320
185	0.25	0.27	0.26	0.37	0.26	0.165	0.30	0.23	0.23	0.32	0.220	0.140	0.260	0.220	0.165	0.280
240	0.19	0.21	0.26	0.33	0.20	0.160	0.25	0.185	0.22	0.29	0.170	0.140	0.220	0.170	0.165	0.240
300	0.155	0.175	0.25	0.31	0.16	0.160	0.22	0.150	0.22	0.27	0.140	0.140	0.195	0.135	0.160	0.210



400	0.12	0.140	0.25	0.29	0.13	0.155	0.20	0.125	0.22	0.25	0.110	0.135	0.175	0.110	0.160	0.195
500	0.093	0.120	0.25	0.28	0.105	0.155	0.185	0.100	0.22	0.24	0.090	0.135	0.160	0.088	0.160	0.180
630	0.072	0.100	0.25	0.27	0.086	0.155	0.175	0.088	0.21	0.23	0.074	0.135	0.150	0.071	0.160	0.170
800	0.056	-	-	-	0.072	0.150	0.170	-	-	-	0.062	0.130	0.145	0.059	0.155	0.165
1000	0.045	-	-	-	0.063	0.150	0.165	-	-	-	0.055	0.130	0.140	0.050	0.155	0.165

FTX300 1RZ1MZ1-R Current-Carrying Capacities (Amp)

Conductor cross-sectional area	Reference Method 1 (clipped direct)		Reference Method 11 (on a perforated horizontal cable tray or Reference Method 13 [free air])		Reference Method 12 (free air)	In single-way ducts		Laid direct in ground	
	2 cables, single-phase a.c. or d.c.	3 or 4 cables, 3-phase a.c.	2 cables, single-phase a.c. or d.c.	3 or 4 cables, 3-phase a.c.	3 cables 3-phase a.c. trefoil touching	2 cables, single-phase a.c. or d.c.	3 or 4 cables, 3-phase a.c.	2 cables, single-phase a.c. or d.c.	3 or 4 cables, 3-phase a.c.
1	2	3	4	5	6	7	8	9	10
mm ²	A	A	A	A	A	A	A	A	A
70	303	277	322	293	285	310	280	340	290
95	367	333	389	352	346	365	330	405	345
120	425	383	449	405	402	410	370	460	389
150	488	437	516	462	463	445	405	510	435
185	557	496	587	524	529	485	440	580	490
240	656	579	689	612	625	550	500	670	560
300	755	662	792	700	720	610	550	750	630
400	853	717	899	767	815	640	580	830	700
500	962	791	1016	851	918	690	620	910	770
630	1082	861	1146	935	1027	750	670	1000	840
800	1170	904	1246	987	1119	828	735	1117	931
1000	1261	961	1345	1055	1214	919	811	1254	1038

Voltage Drop (Per Amp Per Meter)

Conductor cross-sectional area	2 cables d.c.	2 cables single-phase a.c.			3 or 4 cables three-phase a.c.						2 cables singlephase a.c.		3 or 4 cables, 3-phase a.c. touching	
		Reference Method 1 & 11 (touching)			Reference Method 1, 11 & 12 (in trefoil touching)			Reference Method 1 & 11 (Flat touching)			In ducts	In ground	In ducts	In ground
1	2	3			4			5			6	7	8	9
mm ²	mV/A/m	mV/A/m			mV/A/m			mV/A/m			mV/A/m	mV/A/m	mV/A/m	mV/A/m
		r	x	z	r	x	z	r	x	z				
70	0.67	0.68	0.20	0.71	0.59	0.17	0.62	0.6	0.25	0.65	0.80	0.70	0.70	0.61
95	0.49	0.51	0.195	0.55	0.44	0.17	0.47	0.46	0.24	0.52	0.65	0.53	0.56	0.46
120	0.39	0.41	0.190	0.45	0.35	0.165	0.39	0.38	0.24	0.44	0.55	0.43	0.48	0.37
150	0.31	0.33	0.185	0.38	0.29	0.160	0.33	0.31	0.23	0.39	0.50	0.37	0.43	0.32
185	0.25	0.27	0.185	0.33	0.23	0.160	0.28	0.26	0.23	0.34	0.45	0.31	0.39	0.27
240	0.195	0.21	0.180	0.28	0.18	0.155	0.24	0.21	0.22	0.30	0.40	0.26	0.35	0.23
300	0.155	0.17	0.175	0.25	0.145	0.150	0.21	0.17	0.22	0.28	0.37	0.24	0.32	0.21
400	0.115	0.145	0.170	0.22	0.125	0.150	0.195	0.160	0.21	0.27	0.35	0.21	0.30	0.19
500	0.093	0.125	0.170	0.21	0.105	0.145	0.180	0.145	0.20	0.25	0.33	0.20	0.28	0.18
630	0.073	0.105	0.165	0.195	0.092	0.145	0.170	0.135	0.195	0.24	0.30	0.19	0.26	0.17
800	0.056	0.090	0.160	0.190	0.086	0.140	0.165	0.130	0.180	0.23	0.28	0.18	0.24	0.16
1000	0.045	0.092	0.155	0.180	0.080	0.135	0.155	0.125	0.170	0.21	0.26	0.17	0.22	0.15

Note :

r = conductor resistance at operating temperature

x = reactance

z = impedance

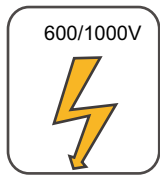

Rated Voltage



Standard



Standard



Standard



Flame Retardancy
NF C32-070-2.1(C2)
IEC60332-1-2/EN50265-2



Highly Flexible



Low Toxicity
NES 02-713/NF C 20-454



Low Corrosivity
IEC60754-2
EN50267-2-2/3
NF C 32-074



Low Smoke Emission
IEC 61034-1&2
EN 50268-1&2/NF C32-073



Reduced Fire Propagation
NF C32-070-2.2(C1)
IEC60332-3-24/EN50266-2-4

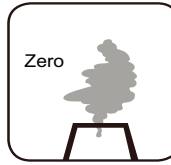

Zero
Halogen Free
IEC60754-1
EN50267-2-1

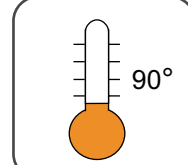

Operating Temperature



600/1000V XLPE Insulated, LSZH Sheathed, Armoured Power Cables (single core) FTX300 1RZ1CZ1MZ1-R (CU/XLPE/CUTO/LSZH/AWA/LSZH 600/1000V Class 2)

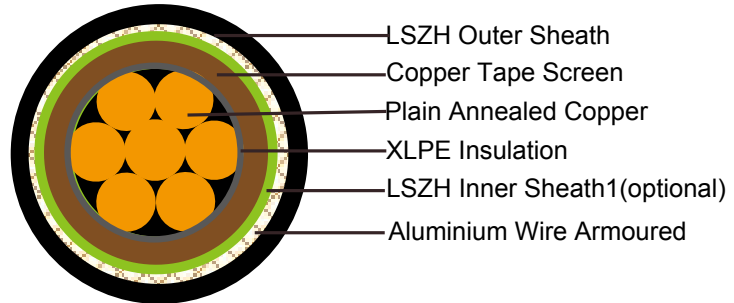

APPLICATION

The cables are mainly used in the conveyer belts, sensors, X rays, automatic sorters in the airport baggage handling system where high flexibility and heat resistance may be required. Ability to operate at high temperature protect this cables from premature aging due to constant exposure to ambient heat generated in the system, while LSZH properties assure low smoke and corrosive gas in the event of a fire.

STANDARDS

Basic design to IEC 60502-1

FIRE PERFORMANCE

Flame Retardance (Single Vertical Wire Test)	EN 60332-1-2; IEC 60332-1-2; BS EN 60332-1-2; VDE 0482-332-1 ; NBN C 30-004 (cat. F1); NF C32-070-2.1(C2); CEI 20-35/1-2; EN 50265-2-1*; DIN VDE 0482-265-2-1*
Reduced Fire Propagation (Vertically-mounted bundled wires & cable test)	EN 60332-3-24 (cat. C); IEC 60332-3-24; BS EN 60332-3-24; VDE 0482-332-3; NBN C 30-004 (cat. F2); NF C32-070-2.2(C1); CEI 20-22/3-4; EN 50266-2-4*; DIN VDE 0482-266-2-4
Halogen Free	IEC 60754-1; EN 50267-2-1; DIN VDE 0482-267-2-1; CEI 20-37/2-1 ; BS 6425-1*
No Corrosive Gas Emission	IEC 60754-2; EN 50267-2-2; DIN VDE 0482-267-2-2; CEI 20-37/2-2 ; BS 6425-2*
Minimum Smoke Emission	IEC 61034-1&2; EN 61034 -1&2; DIN VDE 0482-1034-1&2; CEI 20-37/3-1&2; EN 50268-1&2*; BS 7622-1&2*
No Toxic gases	NES 02-713; NF C 20-454

Note: Asterisk * denotes superseded standard.

VOLTAGE RATING

600/1000V

CABLE CONSTRUCTION

Conductor: Plain annealed copper wire, stranded according to IEC(EN) 60228 class 2.

Insulation: Extruded cross-linked XLPE compound.

Overall Screen: Copper Tape

Inner sheath: LSZH Compound

Armouring: Aluminium Wire

Outer Sheath: Thermoplastic LSZH compound type LTS3 as per BS 7655-6.1 (Thermosetting LSZH compound type SW2-SW4 as per BS 7655-2.6 can be offered.)

COLOUR CODE

Insulation Colour as per BS7671 : Natural

Outer sheath: Black or as order.

PHYSICAL AND THERMAL PROPERTIES

Maximum conductor temperature: Max 90°C for XLPE

Minimum bending radius: 12 x Overall Diameter (for 70mm² to 1000mm²)

CONSTRUCTION PARAMETERS

Conductor		FTX300 1RZ1CZ1MZ1-R						
No. of Core X Cross Section	No./ Nominal Diameter of Strands	Nominal Insulation Thickness	Nominal Sheath Thickness	Diameter Under Screen	Diameter Over Inner Sheath	Armour Wire Diameter	Nominal Overall Diameter	Approx. Weight
mm ²	No./mm	mm	mm	kg/km	mm	mm	mm	kg/km
1x70	19/2.14	1.1	1.8	15.2	17.6	20.1	23.9	1400
1x95	19/2.52	1.1	1.8	17.1	19.5	22.0	25.8	1700
1x120	37/2.03	1.2	1.8	19.0	20.8	24.0	27.8	2000
1x150	37/2.25	1.4	1.8	21.0	22.8	26.0	29.8	2400
1x185	37/2.52	1.6	1.8	23.2	25.0	28.2	32.0	2800
1x240	61/2.25	1.7	1.9	26.1	27.9	31.1	35.1	3500
1x300	61/2.52	1.8	2.0	28.7	30.5	33.7	37.9	4200
1x400	61/2.85	2.0	2.1	32.5	34.3	38.3	42.7	5400
1x500	61/3.20	2.2	2.2	36.0	37.8	41.8	46.4	6500
1x630	127/2.52	2.4	2.3	40.4	42.2	46.2	51.0	8200
1x800	127/2.85	2.6	2.5	45.5	47.3	52.3	57.5	10400
1x1000	127/3.20	2.8	2.7	50.4	52.2	57.2	62.4	13000

ELECTRICAL PROPERTIES

Conductor Operating Temperature : 90°C

Ambient Temperature : 30°C



Current-Carrying Capacities (Amp)

Conductor cross-sectional area	Reference Method 1 (clipped direct)		Reference Method 11 (on a perforated horizontal cable tray or Reference Method 13 [free air])		Reference Method 12 (free air)	In single-way ducts		Laid direct in ground	
	2 cables, single-phase a.c. or d.c.	3 or 4 cables, 3-phase a.c.	2 cables, single-phase a.c. or d.c.	3 or 4 cables, 3-phase a.c.		3 cables 3-phase a.c. trefoil touching	2 cables, single-phase a.c. or d.c.	3 or 4 cables, 3-phase a.c.	2 cables, single-phase a.c. or d.c.
1	2	3	4	5	6	7	8	9	10
mm ²	A	A	A	A	A	A	A	A	A
70	303	277	322	293	285	310	280	340	290
95	367	333	389	352	346	365	330	405	345
120	425	383	449	405	402	410	370	460	389
150	488	437	516	462	463	445	405	510	435
185	557	496	587	524	529	485	440	580	490
240	656	579	689	612	625	550	500	670	560
300	755	662	792	700	720	610	550	750	630
400	853	717	899	767	815	640	580	830	700
500	962	791	1016	851	918	690	620	910	770
630	1082	861	1146	935	1027	750	670	1000	840
800	1170	904	1246	987	1119	828	735	1117	931
1000	1261	961	1345	1055	1214	919	811	1254	1038

Voltage Drop (Per Amp Per Meter)

Conductor cross-sectional area	2 cables d.c.	2 cables single-phase a.c.			3 or 4 cables three-phase a.c.			2 cables singlephase a.c.		3 or 4 cables, 3-phase a.c. touching				
		Reference Method 1 & 11 (touching)			Reference Method 1, 11 & 12 (in trefoil touching)			Reference Method 1 & 11 (Flat touching)		In ducts	In ground	In ducts	In ground	
1	2	3			4			5			6	7	8	9
mm ²	mV/A/m	mV/A/m			mV/A/m			mV/A/m			mV/A/m	mV/A/m	mV/A/m	mV/A/m
		r	x	z	r	x	z	r	x	z				
70	0.67	0.68	0.20	0.71	0.59	0.17	0.62	0.6	0.25	0.65	0.80	0.70	0.70	0.61
95	0.49	0.51	0.195	0.55	0.44	0.17	0.47	0.46	0.24	0.52	0.65	0.53	0.56	0.46
120	0.39	0.41	0.190	0.45	0.35	0.165	0.39	0.38	0.24	0.44	0.55	0.43	0.48	0.37
150	0.31	0.33	0.185	0.38	0.29	0.160	0.33	0.31	0.23	0.39	0.50	0.37	0.43	0.32
185	0.25	0.27	0.185	0.33	0.23	0.160	0.28	0.26	0.23	0.34	0.45	0.31	0.39	0.27
240	0.195	0.21	0.180	0.28	0.18	0.155	0.24	0.21	0.22	0.30	0.40	0.26	0.35	0.23
300	0.155	0.17	0.175	0.25	0.145	0.150	0.21	0.17	0.22	0.28	0.37	0.24	0.32	0.21
400	0.115	0.145	0.170	0.22	0.125	0.150	0.195	0.160	0.21	0.27	0.35	0.21	0.30	0.19
500	0.093	0.125	0.170	0.21	0.105	0.145	0.180	0.145	0.20	0.25	0.33	0.20	0.28	0.18
630	0.073	0.105	0.165	0.195	0.092	0.145	0.170	0.135	0.195	0.24	0.30	0.19	0.26	0.17
800	0.056	0.090	0.160	0.190	0.086	0.140	0.165	0.130	0.180	0.23	0.28	0.18	0.24	0.16
1000	0.045	0.092	0.155	0.180	0.080	0.135	0.155	0.125	0.170	0.21	0.26	0.17	0.22	0.15

Note :

r = conductor resistance at operating temperature

x = reactance

z = impedance

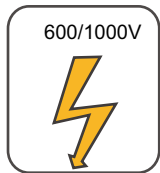

600/1000V

Rated Voltage



IEC60502-1

Standard



Reduced Fire Propagation
NF C32-070-2.2(C1)
IEC60332-3-24/EN50266-2-4



Flame Retardancy
NF C32-070-2.1(C2)
IEC60332-1-2/EN50265-2-1



Highly Flexible



Low Toxicity
NES 02-713/NF C 20-454



Low Corrosivity
IEC60754-2
EN50267-2-2/3
NF C 32-074



Low Smoke Emission
IEC 61034-1&2
EN 50268-1&2/NF C32-073

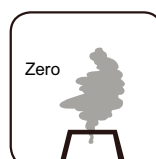

Zero
Halogen Free
IEC60754-1
EN50267-2-1

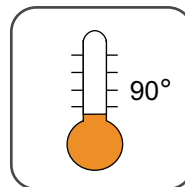

Operating Temperature



600/1000V XLPE Insulated, LSZH Sheathed, Armoured Power Cables (2-4core)

FTX400 1RZ1-R (CU/XLPE/LSZH 600/1000V Class 2)

FTX400 1RZ1MZ1-R (CU/XLPE/LSZH/SWA/LSZH 600/1000V Class 2)

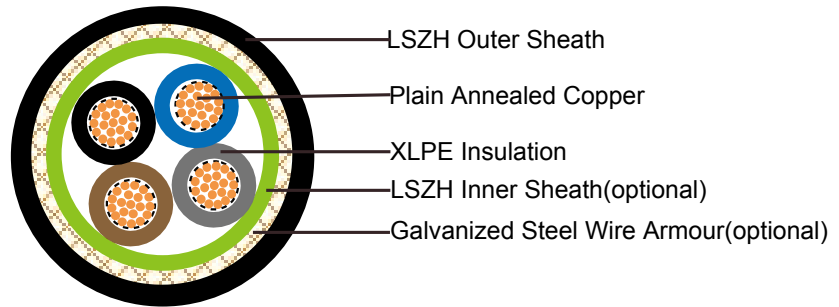
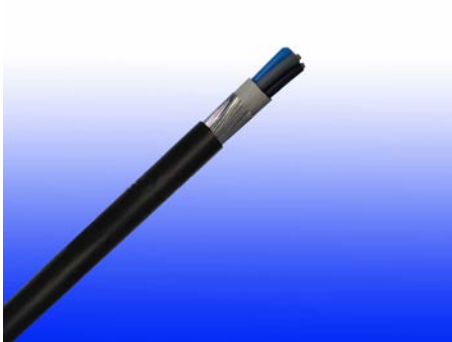

APPLICATION

The cables are mainly used in the conveyer belts, sensors, X rays, automatic sorters in the airport baggage handling system where high flexibility and heat resistance may be required. Ability to operate at high temperature protect this cables from premature aging due to constant exposure to ambient heat generated in the system, while LSZH properties assure low smoke and corrosive gas in the event of a fire.

STANDARDS

Basic design to IEC 60502-1; BS 6724

FIRE PERFORMANCE

Flame Retardance (Single Vertical Wire Test)	EN 60332-1-2; IEC 60332-1-2; BS EN 60332-1-2; VDE 0482-332-1 ; NBN C 30-004 (cat. F1); NF C32-070-2.1(C2); CEI 20-35/1-2; EN 50265-2-1*; DIN VDE 0482-265-2-1*
Reduced Fire Propagation (Vertically-mounted bundled wires & cable test)	EN 60332-3-24 (cat. C); IEC 60332-3-24; BS EN 60332-3-24; VDE 0482-332-3; NBN C 30-004 (cat. F2); NF C32-070-2.2(C1); CEI 20-22/3-4; EN 50266-2-4*; DIN VDE 0482-266-2-4
Halogen Free	IEC 60754-1; EN 50267-2-1; DIN VDE 0482-267-2-1; CEI 20-37/2-1 ; BS 6425-1*
No Corrosive Gas Emission	IEC 60754-2; EN 50267-2-2; DIN VDE 0482-267-2-2; CEI 20-37/2-2 ; BS 6425-2*
Minimum Smoke Emission	IEC 61034-1&2; EN 61034 -1&2; DIN VDE 0482-1034-1&2; CEI 20-37/3-1&2; EN 50268-1&2*; BS 7622-1&2*
No Toxic gases	NES 02-713; NF C 20-454

Note: Asterisk * denotes superseded standard.

VOLTAGE RATING

600/1000V

CABLE CONSTRUCTION

Conductor: Plain annealed copper wire, stranded according to IEC(EN) 60228 class 2.

Insulation: Extruded cross-linked XLPE compound.

Inner Sheath(optional): LSZH Compound

Armouring(optional): Galvanized Steel Wire

Outer Sheath: Thermoplastic LSZH compound type LTS3 as per BS 7655-6.1 (Thermosetting LSZH compound type SW2-SW4 as per BS 7655-2.6 can be offered.)

COLOUR CODE

Insulation Colour as per BS7671

	with earth conductor	without earth conductor
2Cores	-	Brown,Blue
3Cores	Yellow/Green,Brown,Blue	Brown,Gray,Black
4Cores	Yellow/Green,Brown,Gray,Black	Brown,Gray,Black,Blue
5Cores	Yellow/Green,Brown,Gray,Black,Blue	Brown,Gray,Black,Blue,Black
above 5 Cores	Yellow/Green,Black Numbered	Black Numbered

Sheath Colour: Black or as order.

PHYSICAL AND THERMAL PROPERTIES

Temperature range during operation: Max.90°C for XLPE
250°C in short-circuit for 5s max.

Minimum bending radius: 8 x Overall Diameter (unarmoured cable)
10 x Overall Diameter (armoured cable)

CONSTRUCTION PARAMETERS

Conductor			FTX400 1RZ1-R		FTX400 1RZ1MZ1-R			
No. of Core X Cross Section	No./ Nominal Diameter of Strands	Nominal Insulation Thickness	Unarmoured		Armoured			
			Nominal Overall Diameter	Approx. Weight	Diameter Under Armour	Armour Wire Diameter	Nominal Overall Diameter	Approx. Weight
mm ²	No./mm	mm	mm	mm	kg/km	mm	mm	kg/km
2x1.5	7/0.53	0.7	10.0	126	8.5	0.9	13.9	350
2x2.5	7/0.67	0.7	10.8	158	9.3	0.9	14.7	400
2x4	7/0.85	0.7	11.9	205	10.4	0.9	15.8	475
2x6	7/1.04	0.7	13.0	264	11.5	0.9	16.9	560
2x10	7/1.35	0.7	14.9	378	13.4	1.25	19.5	810
2x16	7/1.70	0.7	17.0	534	15.5	1.25	21.6	980
2x25	7/2.14	0.9	20.4	650	18.9	1.6	25.7	1410
2x35	7/2.52	0.9	22.7	880	21.2	1.6	28.0	1930
3x1.5	7/0.53	0.7	10.5	145	9.0	0.9	14.4	390
3x2.5	7/0.67	0.7	11.4	185	9.9	0.9	15.3	450



Caledonian

Flame Retardant Power & Control Cables

www.caledonian-cables.co.uk

www.addison-cables.com



3x4	7/0.85	0.7	12.5	247	11.0	0.9	16.4	540
3x6	7/1.04	0.7	13.8	323	11.6	1.25	17.7	745
3x10	7/1.35	0.7	15.8	474	14.3	1.25	20.4	950
3x16	7/1.70	0.7	18.0	682	16.5	1.25	23.0	1250
3x25	7/2.14	0.9	21.7	910	20.2	1.6	27.0	1840
3x35	7/2.52	0.9	24.0	1180	22.4	1.6	29.2	2050
3x50(S)	19/1.78	1.0	25.5	1600	24.2	1.6	31.2	2590
3x70(S)	19/2.14	1.1	29.0	2240	28.2	2.0	36.2	3560
3x95(S)	19/2.52	1.1	33.5	3050	31.7	2.0	40.1	4590
3x120(S)	37/2.03	1.2	37.5	3800	36.0	2.0	44.6	5810
3x150(S)	37/2.25	1.4	40.5	4640	39.5	2.5	49.5	6920
3x185(S)	37/2.52	1.6	45.0	5870	43.3	2.5	53.5	8340
3x240(S)	61/2.25	1.7	50.5	7670	48.4	2.5	59.0	10450
3x300(S)	61/2.52	1.8	57.0	9460	54.4	2.5	65.4	12700
3x400(S)	61/2.85	2.0	63.0	11945	57.8	2.5	70.0	15326
4x1.5	7/0.53	0.7	11.3	169	10.0	0.9	15.4	430
4x2.5	7/0.67	0.7	12.3	220	10.8	0.9	16.2	505
4x4	7/0.85	0.7	13.6	297	12.1	0.9	17.5	710
4x6	7/1.04	0.7	15.0	392	13.5	1.25	19.6	855
4x10	7/1.35	0.7	17.2	585	15.7	1.25	21.8	1120
4x16	7/1.70	0.7	19.7	851	18.2	1.6	25.0	1600
4x25	7/2.14	0.9	23.9	1200	22.4	1.6	29.2	2160
4x35(S)	7/2.52	0.9	25.0	1600	24.4	1.6	31.4	2560
4x50(S)	19/1.78	1.0	28.0	2200	28.0	1.6	35.2	3180
4x70(S)	19/2.14	1.1	32.0	3050	32.2	2.0	40.6	4490
4x95(S)	19/2.52	1.1	37.0	4070	36.0	2.0	44.6	5725
4x120(S)	37/2.03	1.2	42.0	5915	38.0	2.5	50.0	7550
4x150(S)	37/2.25	1.4	46.0	6350	42.8	2.5	53.0	8555
4x185(S)	37/2.52	1.6	50.0	7890	48.4	2.5	59.0	10560
4x240(S)	61/2.25	1.7	57.0	10400	55.0	2.5	66.0	13180
4x300(S)	61/2.52	1.8	63.0	12810	59.6	2.5	71.0	16100
4x400(S)	61/2.85	2.0	71.0	15869	66.1	3.15	79.4	20715
4x500(S)	61/3.20	2.2	78.0	20300	74.6	3.15	88.5	25347

(S) - Sectoral Stranded Conductors

ELECTRICAL PROPERTIES

Conductor Operating Temperature : 90°C

Ambient Temperature : 30°C

FTX400 1RZ1-R
Current-Carrying Capacities (Amp)

Conductor cross-sectional area	Reference Method 4 (enclosed in conduit in thermally insulating wall etc)		Reference Method 3 (enclosed in conduit on a wall or in trunking etc)		Reference Method 1 (clipped direct)		Reference Method 11 (on a perforated cable tray, horizontal or vertical)		Reference Method 12 (free air)		
	2 cables, single-phase a.c. or d.c.	3 or 4 cables, 3-phase a.c.	2 cables, single-phase a.c. or d.c.	3 or 4 cables, 3-phase a.c.	2 cables, single-phase a.c. or d.c. flat and touching	3 or 4 cables, 3-phase a.c. flat and touching or trefoil	2 cables, single-phase a.c. or d.c. or flat and touching	3 or 4 cables, 3-phase a.c. flat and touching or trefoil	Horizontal flat spaced	Vertical flat spaced	Trefoil
1	2	3	4	5	6	7	8	9	10	11	12
mm ²	A	A	A	A	A	A	A	A	A	A	A
1.5	18	17	22	19	25	23	-	-	-	-	-
2.5	24	23	30	26	34	31	-	-	-	-	-
4	33	30	40	35	46	41	-	-	-	-	-
6	43	39	51	45	59	54	-	-	-	-	-
10	58	53	71	63	81	74	-	-	-	-	-
16	76	70	95	85	109	99	-	-	-	-	-
25	100	91	126	111	143	130	158	140	183	163	138
35	125	111	156	138	176	161	195	176	226	203	171
50	149	135	189	168	228	209	293	215	274	246	209
70	189	170	240	214	293	268	308	279	351	318	270
95	228	205	290	259	355	326	375	341	426	389	330
120	263	235	336	299	413	379	436	398	495	453	385
150	300	270	375	328	476	436	505	461	570	524	445
185	341	306	426	370	545	500	579	530	651	600	511
240	400	358	500	433	644	590	686	630	769	711	606
300	459	410	573	493	743	681	794	730	886	824	701
400	-	-	684	584	868	793	915	849	1065	994	820
500	-	-	783	666	990	904	1044	973	1228	1150	936



Voltage Drop (Per Amp Per Meter)

Size of conductor	2 cables d.c.	2 cables, single-phase a.c.						3 or 4 cables, 3-phase a.c.								
		Ref. Methods 3 and 4 (enclosed in conduit etc, in or on a wall)			Ref. Methods 1 and 11 (clipped direct or on trays touching)			Ref. Methods 3 and 4 (enclosed in conduit etc, in or on a wall)			Ref. Methods 1, 11 and 12 (in trefoil)			Ref. Methods 1 and 11 (Flat and touching)		
1	2	3			4			5			6			7		
mm ²	mV/A/m	mV/A/m			mV/A/m			mV/A/m			mV/A/m			mV/A/m		
1.5	31	31			27			27			27			27		
2.5	19	19			16			16			16			16		
4	33	12			10			10			10			10		
6	7.8	7.9			6.8			6.8			6.8			6.8		
10	4.7	4.7			4.7			4			4			4		
16	2.9	2.9			2.9			2.5			2.5			2.5		
		r	x	z	r	x	z	r	x	z	r	x	z	r	x	z
25	1.85	1.85	0.31	1.90	1.85	0.190	1.85	1.60	0.27	1.65	1.600	0.165	1.600	1.600	0.190	1.600
35	1.35	1.35	0.29	1.35	1.35	0.180	1.35	1.15	0.25	1.15	1.150	0.155	1.50	1.150	0.180	1.150
50	0.99	1.00	0.29	1.05	0.99	0.180	1.00	0.87	0.25	0.90	0.860	0.155	0.870	0.860	0.180	0.870
70	0.68	0.70	0.28	0.75	0.68	0.175	0.71	0.60	0.24	0.65	0.590	0.150	0.610	0.590	0.175	0.620
95	0.49	0.51	0.27	0.58	0.49	0.170	0.52	0.44	0.23	0.50	0.430	0.145	0.450	0.430	0.170	0.460
120	0.39	0.41	0.26	0.48	0.39	0.165	0.43	0.35	0.23	0.42	0.340	0.140	0.370	0.340	0.165	0.380
150	0.32	0.33	0.26	0.43	0.32	0.165	0.36	0.29	0.23	0.37	0.280	0.140	0.310	0.280	0.165	0.320
185	0.25	0.27	0.26	0.37	0.26	0.165	0.30	0.23	0.23	0.32	0.220	0.140	0.260	0.220	0.165	0.280
240	0.19	0.21	0.26	0.33	0.20	0.160	0.25	0.185	0.22	0.29	0.170	0.140	0.220	0.170	0.165	0.240
300	0.155	0.175	0.25	0.31	0.16	0.160	0.22	0.150	0.22	0.27	0.140	0.140	0.195	0.135	0.160	0.210
400	0.12	0.140	0.25	0.29	0.13	0.155	0.20	0.125	0.22	0.25	0.110	0.135	0.175	0.110	0.160	0.195
500	0.093	0.120	0.25	0.28	0.105	0.155	0.185	0.100	0.22	0.24	0.090	0.135	0.160	0.088	0.160	0.180

FTX400 1RZ1MZ1-R

Current-Carrying Capacities (Amp)

Conductor cross-sectional area	Reference Method 1 (clipped direct)		Reference Method 11 (on a perforated horizontal cable tray or Reference Method 13 [free air])		In single-way ducts		Laid direct in ground	
	one 2-core cable single phase a.c. or d.c.	one 3-core or 4-core cable 3-phase a.c.	one 2-core cable single phase a.c. or d.c.	one 3-core or 4-core cable 3-phase a.c.	one 2-core cable single phase a.c. or d.c.	one 3-core or 4-core cable 3-phase a.c.	one 2-core cable single phase a.c. or d.c.	one 3-core or 4-core cable 3-phase a.c.
1	2	3	4	5	6	7	8	9
mm ²	A	A	A	A	A	A	A	A
1.5	27	23	29	25	-	23	-	28
2.5	36	31	39	33	-	30	-	36
4	49	42	52	44	-	40	-	48
6	62	53	66	56	-	50	-	60
10	85	73	90	78	-	65	-	80
16	110	94	115	99	115	94	140	115
25	146	124	152	131	145	125	180	150
35	180	154	188	162	175	150	215	180
50	219	187	228	197	210	175	255	215
70	279	238	291	251	260	215	315	265
95	338	289	354	304	310	260	380	315
120	392	335	410	353	355	300	430	360
150	451	386	472	406	400	335	480	405
185	515	441	539	463	455	380	540	460
240	607	520	636	546	520	440	630	530
300	698	599	732	628	590	495	700	590
400	787	673	847	728	660	560	790	670



Voltage Drop (Per Amp Per Meter)

Conductor cross-sectional area	2-core cable d.c.	2 cables, single-phase a.c.			3 or 4 cables, 3-phase a.c.			2 cables, single-phase a.c.	3 or 4 cables, 3-phase a.c.
		In ducts or in ground			In ducts or in ground			In ducts or in ground	In ducts or in ground
1	2	3			4			5	6
mm ²	mV/A/m	mV/A/m			mV/A/m			mV/A/m	mV/A/m
1.5	31.0	31.0			27.0			31.0	25.0
2.5	19.0	19.0			16.0			19.0	15.0
4	12.0	12.0			10.0			12.0	9.7
6	7.9	7.9			6.8			7.9	6.5
10	4.7	4.7			4.0			4.7	3.9
16	2.9	2.9			2.5			2.9	2.6
		r	x	z	r	x	z		
25	1.850	1.350	0.160	1.900	1.600	0.140	1.650	1.900	1.600
35	1.350	1.350	0.155	1.350	1.150	0.135	1.150	1.350	1.200
50	0.980	0.990	0.155	1.000	0.860	0.135	0.870	1.000	0.870
70	0.670	0.670	0.150	0.690	0.590	0.130	0.600	0.690	0.610
95	0.490	0.500	0.150	0.520	0.430	0.130	0.450	0.520	0.450
120	0.390	0.400	0.145	0.420	0.340	0.130	0.370	0.420	0.360
150	0.310	0.320	0.145	0.350	0.280	0.125	0.300	0.350	0.300
185	0.250	0.260	0.145	0.290	0.220	0.125	0.260	0.290	0.250
240	0.195	0.200	0.140	0.240	0.175	0.125	0.210	0.240	0.210
300	0.155	0.160	0.140	0.210	0.140	0.120	0.185	0.210	0.190
400	0.120	0.130	0.140	0.190	0.115	0.120	0.165	0.190	0.180

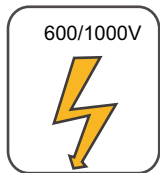

600/1000V

Rated Voltage



IEC 60502-1

Standard



BS 6724

Standard



Reduced Fire Propagation
NF C32-070-2.2(C1)
IEC60332-3-24/EN50266-2-4



Flame Retardancy
NF C32-070-2.1(C2)
IEC60332-1-2/EN50265-2-1

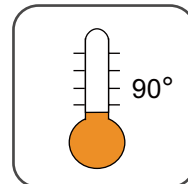

Operating Temperature



Low Toxicity
NES 02-713/NF C 20-454



Low Corrosivity
IEC60754-2
EN50267-2-2/3
NF C 32-074



Low Smoke Emission
IEC 61034-1&2
EN 50268-1&2/NF C32-073

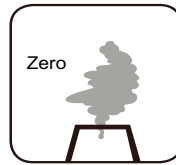

Zero

Halogen Free
IEC60754-1
EN50267-2-1



Highly Flexible

600/1000V XLPE Insulated, LSZH Sheathed, Armoured Power Cables (multicores)

FTX400 1RZ1-R (CU/XLPE/LSZH 600/1000V Class 2)

FTX400 1RZ1MZ1-R (CU/XLPE/LSZH/SWA/LSZH 600/1000V Class 2)

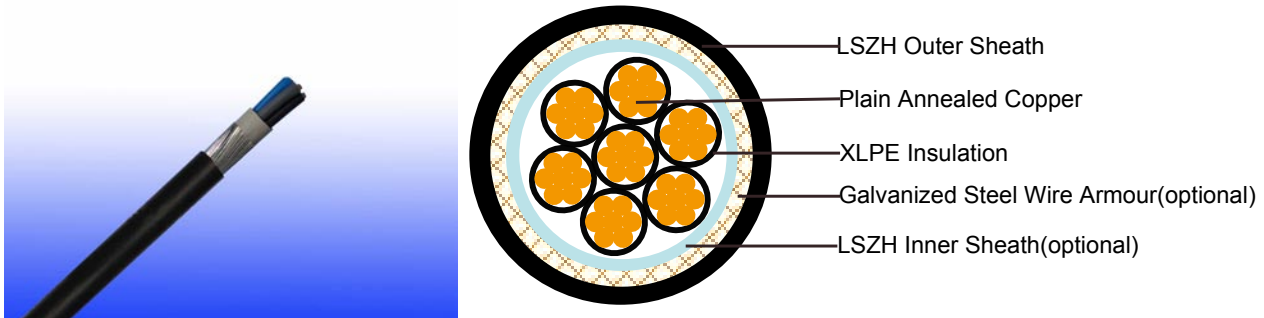

APPLICATION

The cables are mainly used in the conveyer belts, sensors, X rays, automatic sorters in the airport baggage handling system where high flexibility and heat resistance may be required. Ability to operate at high temperature protect this cables from premature aging due to constant exposure to ambient heat generated in the system, while LSZH properties assure low smoke and corrosive gas in the event of a fire.

STANDARDS

Basic design to IEC 60502-1; BS 6724

FIRE PERFORMANCE

Flame Retardance (Single Vertical Wire Test)	EN 60332-1-2; IEC 60332-1-2; BS EN 60332-1-2; VDE 0482-332-1 ; NBN C 30-004 (cat. F1); NF C32-070-2.1(C2); CEI 20-35/1-2; EN 50265-2-1*; DIN VDE 0482-265-2-1*
Reduced Fire Propagation (Vertically-mounted bundled wires & cable test)	EN 60332-3-24 (cat. C); IEC 60332-3-24; BS EN 60332-3-24; VDE 0482-332-3; NBN C 30-004 (cat. F2); NF C32-070-2.2(C1); CEI 20-22/3-4; EN 50266-2-4*; DIN VDE 0482-266-2-4
Halogen Free	IEC 60754-1; EN 50267-2-1; DIN VDE 0482-267-2-1; CEI 20-37/2-1 ; BS 6425-1*
No Corrosive Gas Emission	IEC 60754-2; EN 50267-2-2; DIN VDE 0482-267-2-2; CEI 20-37/2-2 ; BS 6425-2*
Minimum Smoke Emission	IEC 61034-1&2; EN 61034 -1&2; DIN VDE 0482-1034-1&2; CEI 20-37/3-1&2; EN 50268-1&2*; BS 7622-1&2*
No Toxic gases	NES 02-713; NF C 20-454

Note: Asterisk * denotes superseded standard.

VOLTAGE RATING

600/1000V



CABLE CONSTRUCTION

Conductor: Plain annealed copper wire, stranded according to IEC(EN) 60228 class 2.

Insulation: Extruded cross-linked XLPE compound.

Inner Sheath(optional): LSZH Compound

Armouring(optional): Galvanized Steel Wire

Outer Sheath: Thermoplastic LSZH compound type LTS3 as per BS 7655-6.1 (Thermosetting LSZH compound type SW2-SW4 as per BS 7655-2.6 can be offered.)

COLOUR CODE

Insulation Colour as per BS7671

	with earth conductor	without earth conductor
2Cores	-	Brown,Blue
3Cores	Yellow/Green,Brown,Blue	Brown,Gray,Black
4Cores	Yellow/Green,Brown,Gray,Black	Brown,Gray,Black,Blue
5Cores	Yellow/Green,Brown,Gray,Black,Blue	Brown,Gray,Black,Blue,Black
above 5 Cores	Yellow/Green,Black Numbered	Black Numbered

Sheath Colour: Black or as order.

PHYSICAL AND THERMAL PROPERTIES

Temperature range during operation: Max.90°C for XLPE
250°C in short-circuit for 5s max.

Minimum bending radius: 8 x Overall Diameter (unarmoured cable)
10 x Overall Diameter (armoured cable)

CONSTRUCTION PARAMETERS

No. of Core X Cross Section	Conductor		FTX400 1RZ1-R		FTX400 1RZ1MZ1-R			
	No./ Nominal Diameter of Strands	Nominal Insulation Thickness	Unarmoured		Armoured			
			Nominal Overall Diameter	Approx. Weight	Diameter Under Armour	Armour Wire Diameter	Nominal Overall Diameter	Approx. Weight
mm ²	No./mm	mm	mm	kg/km	No./mm	mm	mm	kg/km
5x1.5	7/0.53	0.7	11.3	184	9.9	0.9	14.5	402
7x1.5	7/0.53	0.7	12.4	225	11.2	0.9	16.0	490
10x1.5	7/0.53	0.7	15.6	325	14.3	1.25	20.0	761
12x1.5	7/0.53	0.7	16.2	370	14.8	1.25	20.5	827
19x1.5	7/0.53	0.7	19.0	516	17.4	1.6	24.0	1186
27x1.5	7/0.53	0.7	22.7	712	21.3	1.6	28.1	1537
37x1.5	7/0.53	0.7	25.5	941	23.9	1.6	30.7	1856
48x1.5	7/0.53	0.7	29.0	1186	27.5	1.6	34.6	2276
5x2.5	7/0.67	0.7	12.8	237	11.2	0.9	15.8	496
7x2.5	7/0.67	0.7	13.8	303	12.4	0.9	17.2	602

10x2.5	7/0.67	0.7	17.5	426	15.9	1.25	21.8	943
12x2.5	7/0.67	0.7	18.1	489	16.5	1.25	22.4	1020
19x2.5	7/0.67	0.7	21.3	725	19.9	1.6	26.7	1498
27x2.5	7/0.67	0.7	25.5	1004	23.9	1.6	30.9	1933
37x2.5	7/0.67	0.7	28.7	1334	26.9	1.6	33.9	2372
48x2.5	7/0.67	0.7	32.9	1706	31.3	2.0	39.6	3252
5x4	7/0.85	0.7	14.2	324	12.6	1.25	18.2	712
7x4	7/0.85	0.7	15.5	422	14.1	1.25	19.8	871
10x4	7/0.85	0.7	19.7	597	18.5	1.25	24.4	1213
12x4	7/0.85	0.7	20.3	690	19.1	1.6	25.7	1462
19x4	7/0.85	0.7	24.0	1037	22.6	1.6	29.4	1931
27x4	7/0.85	0.7	28.8	1445	27.2	1.6	34.4	2532
37x4	7/0.85	0.7	32.5	1932	31.1	2.0	39.3	3448
48x4	7/0.85	0.7	37.3	2479	35.7	2.0	44.2	4273

Note : Other conductor sizes & core configurations are available upon request.

ELECTRICAL PROPERTIES

Conductor Operating Temperature : 90°C

Ambient Temperature : 30°C

FTX400 1RZ1-R

Current-Carrying Capacities (Amp)

Conductor cross-sectional area	Reference Method 4 (enclosed in conduit in thermally insulating wall etc)		Reference Method 3 (enclosed in conduit on a wall or in trunking etc)		Reference Method 1 (clipped direct)		Reference Method 11 (on a perforated cable tray, horizontal or vertical)		Reference Method 12 (free air)		
	Horizontal flat spaced	Vertical flat spaced	Trefoil	2 cables, single-phase a.c. or d.c.	3 or 4 cables, 3-phase a.c.	2 cables, single-phase a.c. or d.c. flat and touching	3 or 4 cables, 3-phase a.c. flat and touching or trefoil	2 cables, single-phase a.c. or d.c. flat and touching	3 or 4 cables, 3-phase a.c. flat and touching or trefoil	2 cables, single-phase a.c. or d.c. or 3 cables three phase	2 cables, single-phase a.c. or d.c. or 3 cables three phase
1	2	3	4	5	6	7	8	9	10	11	12
mm ²	A	A	A	A	A	A	A	A	A	A	A



1.5	18	17	22	19	25	23	-	-	-	-	-
2.5	24	23	30	26	34	31	-	-	-	-	-
4	33	30	40	35	46	41	-	-	-	-	-

Voltage Drop (Per Amp Per Meter)

Nominal Cross Section Area	2 cables d.c.	2 cables, single-phase a.c.		3 or 4 cables, 3-phase a.c.		
		Ref. Methods 3 and 4 (enclosed in conduit etc, in or on a wall)	Ref. Methods 1 and 11 (clipped direct or on trays touching)	Ref. Methods 3 and 4 (enclosed in conduit etc, in or on a wall)	Ref. Methods 1,	Ref. Methods 1 and 11
					11 and 12 (in trefoil)	(Flat and touching)
1	2	3	4	5	6	7
mm ²	mV/A/m	mV/A/m	mV/A/m	mV/A/m	mV/A/m	mV/A/m
1.5	31	31	27	27	27	27
2.5	19	19	16	16	16	16
4	33	12	10	10	10	10

FTX400 1RZ1MZ1-R

Current-Carrying Capacities (Amp)

Conductor cross-sectional area	Reference Method 1 (clipped direct)		Reference Method 11 (on a perforated horizontal cable tray or Reference Method 13 [free air])		In single-way ducts		Laid direct in ground	
	one 2-core cable single phase a.c. or d.c.	one 3-core or 4-core cable 3-phase a.c.	one 2-core cable single phase a.c. or d.c.	one 3-core or 4-core cable 3-phase a.c.	one 2-core cable single phase a.c. or d.c.	one 3-core or 4-core cable 3-phase a.c.	one 2-core cable single phase a.c. or d.c.	one 3-core or 4-core cable 3-phase a.c.
1	2	3	4	5	6	7	8	9
mm ²	A	A	A	A	A	A	A	A
1.5	27	23	29	25	-	23	-	28
2.5	36	31	39	33	-	30	-	36
4	49	42	52	44	-	40	-	48

Voltage Drop (Per Amp Per Meter)

Conductor cross-sectional area	2-core cable d.c.	2 cables, single-phase a.c.	3 or 4 cables, 3-phase a.c.	2 cables, single-phase a.c.	3 or 4 cables, 3-phase a.c.
				In ducts or in ground	In ducts or in ground
1	2	3	4	5	6
mm ²	mV/A/m	mV/A/m	mV/A/m	mV/A/m	mV/A/m
1.5	31.0	31.0	27.0	31.0	25.0
2.5	19.0	19.0	16.0	19.0	15.0
4	12.0	12.0	10.0	12.0	9.7

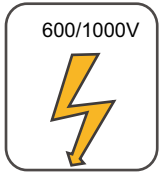

Rated Voltage



Standard



Standard



Reduced Fire Propagation
NF C32-070-2.2(C1)
IEC60332-3-24/EN50266-2-4



Flame Retardancy
NF C32-070-2.1(C2)
IEC60332-1-2/EN50265-2-1

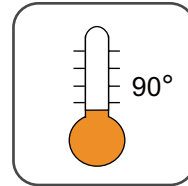

Operating Temperature



Low Toxicity
NES 02-713/NF C 20-454



Low Corrosivity
IEC60754-2
EN50267-2-2/3
NF C 32-074



Low Smoke Emission
IEC 61034-1&2
EN 50268-1&2/NF C32-073

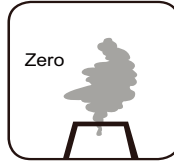

Halogen Free
IEC60754-1
EN50267-2-1



Highly Flexible



600/1000V XLPE Insulated, LSZH Sheathed, Screened Power Cables (4core)

FTX400 1RCZ1MZ1-R (CU/XLPE/CUTO/LSZH/SWA/LSZH 600/1000V Class 2)

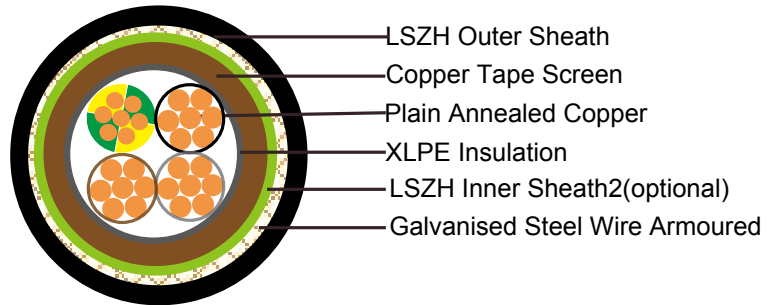
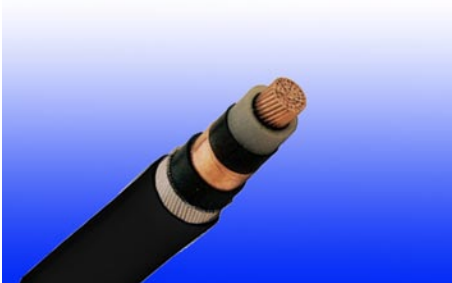

APPLICATION

The cables are mainly used in the conveyer belts, sensors, X rays, automatic sorters in the airport baggage handling system where high flexibility and heat resistance may be required. Ability to operate at high temperature protect this cables from premature aging due to constant exposure to ambient heat generated in the system, while LSZH properties assure low smoke and corrosive gas in the event of a fire.

STANDARDS

Basic design to IEC 60502-1

FIRE PERFORMANCE

Flame Retardance (Single Vertical Wire Test)	EN 60332-1-2; IEC 60332-1-2; BS EN 60332-1-2; VDE 0482-332-1 ; NBN C 30-004 (cat. F1); NF C32-070-2.1(C2); CEI 20-35/1-2; EN 50265-2-1*; DIN VDE 0482-265-2-1*
Reduced Fire Propagation (Vertically-mounted bundled wires & cable test)	EN 60332-3-24 (cat. C); IEC 60332-3-24; BS EN 60332-3-24; VDE 0482-332-3; NBN C 30-004 (cat. F2); NF C32-070-2.2(C1); CEI 20-22/3-4; EN 50266-2-4*; DIN VDE 0482-266-2-4
Halogen Free	IEC 60754-1; EN 50267-2-1; DIN VDE 0482-267-2-1; CEI 20-37/2-1 ; BS 6425-1*
No Corrosive Gas Emission	IEC 60754-2; EN 50267-2-2; DIN VDE 0482-267-2-2; CEI 20-37/2-2 ; BS 6425-2*
Minimum Smoke Emission	IEC 61034-1&2; EN 61034 -1&2; DIN VDE 0482-1034-1&2; CEI 20-37/3-1&2; EN 50268-1&2*; BS 7622-1&2*
No Toxic gases	NES 02-713; NF C 20-454

Note: Asterisk * denotes superseded standard.

VOLTAGE RATING

600/1000V

CABLE CONSTRUCTION

Conductor: Plain annealed copper wire, stranded according to IEC(EN) 60228 class 2.

Insulation: Extruded cross-linked XLPE compound.

Inner sheath1: LSZH Compound

Screen: Copper Tape

Inner sheath2: LSZH Compound

Armouring: Galvanised Steel Wire

Outer Sheath: Thermoplastic LSZH compound type LTS3 as per BS 7655-6.1 (Thermosetting LSZH compound type SW2-SW4 as per BS 7655-2.6 can be offered.)

COLOUR CODE

Insulation Colour as per BS7671

	with earth conductor	without earth conductor
2Cores	-	Brown,Blue
3Cores	Yellow/Green,Brown,Blue	Brown,Gray,Black
4Cores	Yellow/Green,Brown,Gray,Black	Brown,Gray,Black,Blue
5Cores	Yellow/Green,Brown,Gray,Black,Blue	Brown,Gray,Black,Blue,Black
above 5 Cores	Yellow/Green,Black Numbered	Black Numbered

Sheath Colour: Black or as order

PHYSICAL AND THERMAL PROPERTIES

Temperature range during operation: Max.90°C for XLPE
250°C in short-circuit for 5s max.

Minimum bending radius: 12 x Overall Diameter (for 1.5mm² to 300mm²)

CONSTRUCTION PARAMETERS

Conductor		FTX400 1RCZ1MZ1-R						
No. of Core X Cross Section	No./ Nominal Diameter of Strands	Nominal Insulation Thickness	Nominal Sheath Thickness	Diameter Under Screen	Diameter Over Inner Sheath	Armour Wire Diameter	Nominal Overall Diameter	Approx. Weight
mm ²	No./mm	mm	mm	kg/km	mm	mm	mm	kg/km
4x1.5	7/0.53	0.7	1.8	9.7	12.1	13.9	17.7	640
4x2.5	7/0.67	0.7	1.8	10.7	13.1	14.9	18.7	730
4x4	7/0.85	0.7	1.8	12.0	14.4	16.2	20.0	870
4x6	7/1.04	0.7	1.8	13.4	15.8	18.3	22.1	1180
4x10	7/1.35	0.7	1.8	15.6	18.0	20.5	24.3	1490
4x16	7/1.70	0.7	1.8	18.1	20.5	23.7	27.5	2070
4x25	7/2.14	0.9	1.8	22.3	24.1	27.3	31.1	2790
4x35(S)	7/2.52	0.9	1.8	25.0	26.8	30.0	33.8	2940
4x50(S)	19/1.78	1.0	2.0	27.8	29.6	32.8	37.0	3500
4x70(S)	19/2.14	1.1	2.2	31.6	33.4	37.4	42.0	5000



4x95(S)	19/2.52	1.1	2.3	35.4	37.2	41.2	46.0	6300
4x120(S)	37/2.03	1.2	2.5	39.0	40.8	45.8	51.0	8200
4x150(S)	37/2.25	1.4	2.6	42.0	43.8	48.8	54.2	9600
4x185(S)	37/2.52	1.6	2.8	47.8	49.6	54.6	60.4	11500
4x240(S)	61/2.25	1.7	3.0	54.0	55.8	60.8	67.0	14400
4x300(S)	61/2.52	1.8	3.0	58.0	59.8	64.8	71.4	17200

(S) : Sectoral Stranded Conductors.

ELECTRICAL PROPERTIES

Conductor Operating Temperature : 90°C

Ambient Temperature : 30°C

Current-Carrying Capacities (Amp)

Conductor cross-sectional area	Reference Method 1 (clipped direct)		Reference Method 11 (on a perforated horizontal cable tray or Reference Method 13 [free air])		In single-way ducts		Laid direct in ground	
	one 2-core cable single phase a.c. or d.c.	one 3-core or 4-core cable 3-phase a.c.	one 2-core cable single phase a.c. or d.c.	one 3-core or 4-core cable 3-phase a.c.	one 2-core cable single phase a.c. or d.c.	one 3-core or 4-core cable 3-phase a.c.	one 2-core cable single phase a.c. or d.c.	one 3-core or 4-core cable 3-phase a.c.
1	2	3	4	5	6	7	8	9
mm ²	A	A	A	A	A	A	A	A
1.5	27	23	29	25	-	23	-	28
2.5	36	31	39	33	-	30	-	36
4	49	42	52	44	-	40	-	48
6	62	53	66	56	-	50	-	60
10	85	73	90	78	-	65	-	80
16	110	94	115	99	115	94	140	115
25	146	124	152	131	145	125	180	150
35	180	154	188	162	175	150	215	180
50	219	187	228	197	210	175	255	215
70	279	238	291	251	260	215	315	265
95	338	289	354	304	310	260	380	315
120	392	335	410	353	355	300	430	360
150	451	386	472	406	400	335	480	405
185	515	441	539	463	455	380	540	460
240	607	520	636	546	520	440	630	530
300	698	599	732	628	590	495	700	590

Voltage Drop (Per Amp Per Meter)

Conductor cross-sectional area	2-core cable d.c.	2 cables, single-phase a.c.			3 or 4 cables, 3-phase a.c.			2 cables, single-phase a.c.	3 or 4 cables, 3-phase a.c.
								In ducts or in ground	In ducts or in ground
1	2	3			4			5	6
mm ²	mV/A/m	mV/A/m			mV/A/m			mV/A/m	mV/A/m
1.5	31.0	31.0			27.0			31.0	25.0
2.5	19.0	19.0			16.0			19.0	15.0
4	12.0	12.0			10.0			12.0	9.7
6	7.9	7.9			6.8			7.9	6.5
10	4.7	4.7			4.0			4.7	3.9
16	2.9	2.9			2.5			2.9	2.6
		r	x	z	r	x	z		
25	1.850	1.350	0.160	1.900	1.600	0.140	1.650	1.900	1.600
35	1.350	1.350	0.155	1.350	1.150	0.135	1.150	1.350	1.200
50	0.980	0.990	0.155	1.000	0.860	0.135	0.870	1.000	0.870
70	0.670	0.670	0.150	0.690	0.590	0.130	0.600	0.690	0.610
95	0.490	0.500	0.150	0.520	0.430	0.130	0.450	0.520	0.450
120	0.390	0.400	0.145	0.420	0.340	0.130	0.370	0.420	0.360
150	0.310	0.320	0.145	0.350	0.280	0.125	0.300	0.350	0.300
185	0.250	0.260	0.145	0.290	0.220	0.125	0.260	0.290	0.250
240	0.195	0.200	0.140	0.240	0.175	0.125	0.210	0.240	0.210
300	0.155	0.160	0.140	0.210	0.140	0.120	0.185	0.210	0.190

Note :

r = conductor resistance at operating temperature

x = reactance

z = impedance

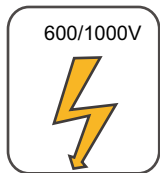

600/1000V

Rated Voltage



IEC 60502-1

Standard



Reduced Fire Propagation
NF C32-070-2.2(C1)
IEC60332-3-24/EN50266-2-4



Flame Retardancy
NF C32-070-2.1(C2)
IEC60332-1-2/EN50265-2-1

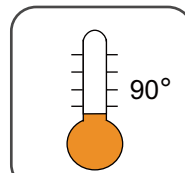

Operating Temperature



Low Toxicity
NES 02-713/NF C 20-454



Low Corrosivity
IEC60754-2
EN50267-2-2/3
NF C 32-074



Low Smoke Emission
IEC 61034-1&2
EN 50268-1&2/NF C32-073

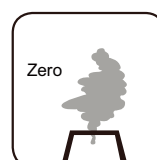

Zero
Halogen Free
IEC60754-1
EN50267-2-1



Highly Flexible



600/1000V XLPE Insulated, LSZH Sheathed, Screened Power Cables (3C+3E)

FTX300 1RCZ1-R (CU/XLPE/CUTO/LSZH 600/1000V Class 2)

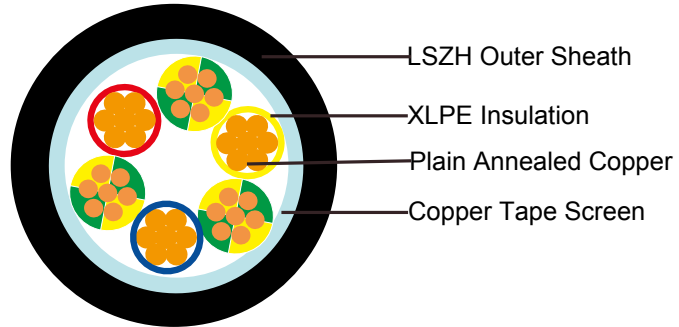

APPLICATION

The cables are mainly used in the conveyer belts, sensors, X rays, automatic sorters in the airport baggage handling system where high flexibility and heat resistance may be required. Ability to operate at high temperature protect this cables from premature aging due to constant exposure to ambient heat generated in the system, while LSZH properties assure low smoke and corrosive gas in the event of a fire.

STANDARDS

Basic design to IEC 60502-1

FIRE PERFORMANCE

Flame Retardance (Single Vertical Wire Test)	EN 60332-1-2; IEC 60332-1-2; BS EN 60332-1-2; VDE 0482-332-1 ; NBN C 30-004 (cat. F1); NF C32-070-2.1(C2); CEI 20-35/1-2; EN 50265-2-1*; DIN VDE 0482-265-2-1*
Reduced Fire Propagation (Vertically-mounted bundled wires & cable test)	EN 60332-3-24 (cat. C); IEC 60332-3-24; BS EN 60332-3-24; VDE 0482-332-3; NBN C 30-004 (cat. F2); NF C32-070-2.2(C1); CEI 20-22/3-4; EN 50266-2-4*; DIN VDE 0482-266-2-4
Halogen Free	IEC 60754-1; EN 50267-2-1; DIN VDE 0482-267-2-1; CEI 20-37/2-1 ; BS 6425-1*
No Corrosive Gas Emission	IEC 60754-2; EN 50267-2-2; DIN VDE 0482-267-2-2; CEI 20-37/2-2 ; BS 6425-2*
Minimum Smoke Emission	IEC 61034-1&2; EN 61034 -1&2; DIN VDE 0482-1034-1&2; CEI 20-37/3-1&2; EN 50268-1&2*; BS 7622-1&2*
No Toxic gases	NES 02-713; NF C 20-454

Note: Asterisk * denotes superseded standard.

VOLTAGE RATING

600/1000V

CABLE CONSTRUCTION

Conductor: Plain annealed copper wire, stranded according to IEC(EN) 60228 class 2.

Insulation: Extruded cross-linked XLPE compound.

Screen: Copper Tape

Outer Sheath: Thermoplastic LSZH compound type LTS3 as per BS 7655-6.1 (Thermosetting LSZH compound type SW2-SW4 as per BS 7655-2.6 can be offered.)

COLOUR CODE

Insulation Colour: Red, Yellow, Blue, Green/Yellow (x3)

Outer sheath: Black or as order

PHYSICAL AND THERMAL PROPERTIES

Temperature range during operation: Max.90°C for XLPE
250°C in short-circuit for 5s max.

Minimum bending radius: 10 x Overall Diameter

CONSTRUCTION PARAMETERS

Conductor			FTX300 1RCZ1-R			
No. of Core X Cross Section	No./Nominal Diameter of Strands	Combined Earth Size	Nominal Insulation Thickness	Nominal Sheath Thickness	Nominal Overall Diameter	Approx. Weight
mm ²	No./mm	mm ²	mm	mm	mm	kg/km
3x1.5	7/0.53	4.5(3x1.5)	0.7	1.8	13.6	325
3x2.5	7/0.67	4.5(3x1.5)	0.7	1.8	14.8	380
3x4	7/0.85	4.5(3x1.5)	0.7	1.8	15.8	440
3x6	7/1.04	7.5(3x2.5)	0.7	1.8	16.9	550
3x10	7/1.35	12(3x4)	0.7	1.8	18.6	750
3x16	7/1.70	18(3x6)	0.7	1.8	20.8	1000
3x25	7/2.14	30(3x10)	0.9	1.8	24.0	1470
3x35	7/2.52	30(3x10)	0.9	1.8	25.6	1890
3x50	19/1.78	30(3x10)	1.0	1.9	31.1	2300
3x70	19/2.14	48(3x16)	1.1	2.0	34.6	3200
3x95	19/2.52	48(3x16)	1.1	2.2	39.3	4200
3x120	37/2.03	75(3x25)	1.2	2.3	44.0	5400
3x150	37/2.25	75(3x25)	1.4	2.5	49.0	6400
3x185	37/2.52	105(3x35)	1.6	2.6	54.0	7900
3x240	61/2.25	150(3x50)	1.7	2.8	61.0	10200
3x300	61/2.52	150(3x50)	1.8	3.0	67.0	12300

ELECTRICAL PROPERTIES

Conductor Operating Temperature : 90°C

Ambient Temperature : 30°C

Current-Carrying Capacities (Amp)



Conductor cross-sectional area	Reference Method 4 (enclosed in conduit in thermally insulating wall etc)		Reference Method 3 (enclosed in conduit on a wall or in trunking etc)		Reference Method 1 (clipped direct)		Reference Method 11 (on a perforated cable tray, horizontal or vertical)		Reference Method 12 (free air)		
	2 cables, single-phase a.c. or d.c.	3 or 4 cables, 3-phase a.c.	2 cables, single-phase a.c. or d.c.	3 or 4 cables, 3-phase a.c.	2 cables, single-phase a.c. or d.c. flat and touching	3 or 4 cables, 3-phase a.c. flat and touching or trefoil	2 cables, single-phase a.c. or d.c. or flat and touching	3 or 4 cables, 3-phase a.c. flat and touching or trefoil	Horizontal flat spaced	Vertical flat spaced	Trefoil
1	2	3	4	5	6	7	8	9	10	11	12
mm ²	A	A	A	A	A	A	A	A	A	A	A
1.5	18	17	22	19	25	23	-	-	-	-	-
2.5	24	23	30	26	34	31	-	-	-	-	-
4	33	30	40	35	46	41	-	-	-	-	-
6	43	39	51	45	59	54	-	-	-	-	-
10	58	53	71	63	81	74	-	-	-	-	-
16	76	70	95	85	109	99	-	-	-	-	-
25	100	91	126	111	143	130	158	140	183	163	138
35	125	111	156	138	176	161	195	176	226	203	171
50	149	135	189	168	228	209	293	215	274	246	209
70	189	170	240	214	293	268	308	279	351	318	270
95	228	205	290	259	355	326	375	341	426	389	330
120	263	235	336	299	413	379	436	398	495	453	385
150	300	270	375	328	476	436	505	461	570	524	445
185	341	306	426	370	545	500	579	530	651	600	511
240	400	358	500	433	644	590	686	630	769	711	606
300	459	410	573	493	743	681	794	730	886	824	701

Voltage Drop (Per Amp Per Meter)

Size of conductor	2 cables d.c.	2 cables, single-phase a.c.		3 or 4 cables, 3-phase a.c.		
		Ref. Methods 3 and 4 (enclosed in conduit etc, in or on a wall)	Ref. Methods 1 and 11 (clipped direct or on trays touching)	Ref. Methods 3 and 4 (enclosed in conduit etc, in or on a wall)	Ref. Methods 1, 11 and 12 (in trefoil)	Ref. Methods 1 and 11 (Flat and touching)
1	2	3	4	5	6	7

mm ²	mV/A/m			mV/A/m			mV/A/m			mV/A/m			mV/A/m			
1.5	31	31	31	27	27	27	27	27	27	27	27	27	27	27	27	
2.5	19	19	19	16	16	16	16	16	16	16	16	16	16	16	16	
4	33	12	12	10	10	10	10	10	10	10	10	10	10	10	10	
6	7.8	7.9	7.9	6.8	6.8	6.8	6.8	6.8	6.8	6.8	6.8	6.8	6.8	6.8	6.8	
10	4.7	4.7	4.7	4.7	4	4	4	4	4	4	4	4	4	4	4	
16	2.9	2.9	2.9	2.9	2.5	2.5	2.5	2.5	2.5	2.5	2.5	2.5	2.5	2.5	2.5	
		r	x	z	r	x	z	r	x	z	r	x	z	r	x	z
25	1.85	1.85	0.31	1.90	1.85	0.190	1.85	1.60	0.27	1.65	1.600	0.165	1.600	1.600	0.190	1.600
35	1.35	1.35	0.29	1.35	1.35	0.180	1.35	1.15	0.25	1.15	1.150	0.155	1.50	1.150	0.180	1.150
50	0.99	1.00	0.29	1.05	0.99	0.180	1.00	0.87	0.25	0.90	0.860	0.155	0.870	0.860	0.180	0.870
70	0.68	0.70	0.28	0.75	0.68	0.175	0.71	0.60	0.24	0.65	0.590	0.150	0.610	0.590	0.175	0.620
95	0.49	0.51	0.27	0.58	0.49	0.170	0.52	0.44	0.23	0.50	0.430	0.145	0.450	0.430	0.170	0.460
120	0.39	0.41	0.26	0.48	0.39	0.165	0.43	0.35	0.23	0.42	0.340	0.140	0.370	0.340	0.165	0.380
150	0.32	0.33	0.26	0.43	0.32	0.165	0.36	0.29	0.23	0.37	0.280	0.140	0.310	0.280	0.165	0.320
185	0.25	0.27	0.26	0.37	0.26	0.165	0.30	0.23	0.23	0.32	0.220	0.140	0.260	0.220	0.165	0.280
240	0.19	0.21	0.26	0.33	0.20	0.160	0.25	0.185	0.22	0.29	0.170	0.140	0.220	0.170	0.165	0.240
300	0.155	0.175	0.25	0.31	0.16	0.160	0.22	0.150	0.22	0.27	0.140	0.140	0.195	0.135	0.160	0.210

Note :

r = conductor resistance at operating temperature

x = reactance

z = impedance



Rated Voltage



Standard



Reduced Fire Propagation
NF C32-070-2.2(C1)
IEC60332-3-24/EN50266-2-4



Flame Retardancy
NF C32-070-2.1(C2)
IEC60332-1-2/EN50265-2-1

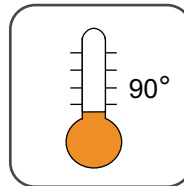

Operating Temperature



Low Toxicity
NES 02-713/NF C 20-454



Low Corrosivity
IEC60754-2
EN50267-2-2/3
NF C 32-074



Low Smoke Emission
IEC 61034-1&2
EN 50268-1&2/NF C32-073

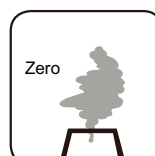

Zero
Halogen Free
IEC60754-1
EN50267-2-1



Highly Flexible



600/1000V XLPE Insulated, LSZH Sheathed, Double steel tape armoured Power Cables (2core)

FTX400 1RZ1MZ1-R (CU/XLPE/LSZH/DSTA/LSZH 600/1000V Class 2)

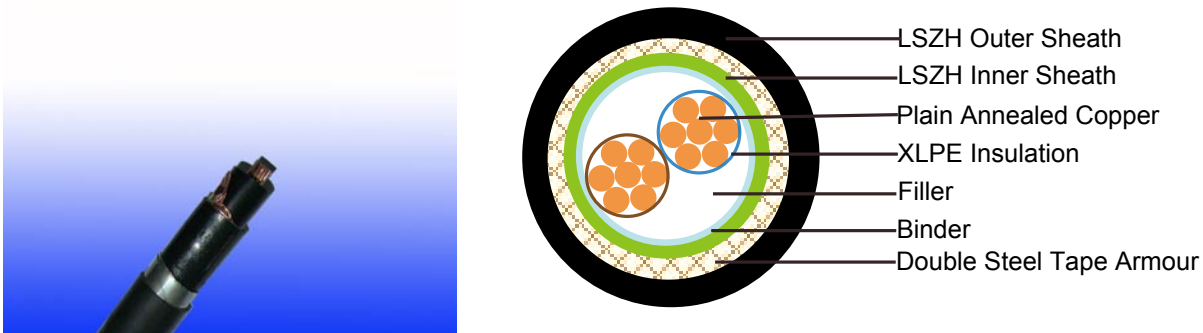

APPLICATION

The cables are mainly used in the conveyer belts, sensors, X rays, automatic sorters in the airport baggage handling system where high flexibility and heat resistance may be required. Ability to operate at high temperature protect this cables from premature aging due to constant exposure to ambient heat generated in the system, while LSZH properties assure low smoke and corrosive gas in the event of a fire.

STANDARDS

Basic design to IEC 60502 -1

FIRE PERFORMANCE

Flame Retardance (Single Vertical Wire Test)	EN 60332-1-2; IEC 60332-1-2; BS EN 60332-1-2; VDE 0482-332-1 ; NBN C 30-004 (cat. F1); NF C32-070-2.1(C2); CEI 20-35/1-2; EN 50265-2-1*; DIN VDE 0482-265-2-1*
Reduced Fire Propagation (Vertically-mounted bundled wires & cable test)	EN 60332-3-24 (cat. C); IEC 60332-3-24; BS EN 60332-3-24; VDE 0482-332-3; NBN C 30-004 (cat. F2); NF C32-070-2.2(C1); CEI 20-22/3-4; EN 50266-2-4*; DIN VDE 0482-266-2-4
Halogen Free	IEC 60754-1; EN 50267-2-1; DIN VDE 0482-267-2-1; CEI 20-37/2-1 ; BS 6425-1*
No Corrosive Gas Emission	IEC 60754-2; EN 50267-2-2; DIN VDE 0482-267-2-2; CEI 20-37/2-2 ; BS 6425-2*
Minimum Smoke Emission	IEC 61034-1&2; EN 61034 -1&2; DIN VDE 0482-1034-1&2; CEI 20-37/3-1&2; EN 50268-1&2*; BS 7622-1&2*
No Toxic gases	NES 02-713; NF C 20-454

Note: Asterisk * denotes superseded standard.

VOLTAGE RATING

600/1000V

CABLE CONSTRUCTION

Conductor: Plain annealed copper wire, normal stranded or compact stranded according to IEC(EN)

60228 class 2.

Insulation: Extruded cross-linked XLPE compound.

Filler, binder and inner covering: PP, PET, LSZH

Armouring: Double steel tape

Outer Sheath: Thermoplastic LSZH compound type LTS3 as per BS 7655-6.1 (Thermosetting LSZH compound type SW2-SW4 as per BS 7655-2.6 can be offered.)

COLOUR CODE

Insulation Colour as per BS7671

	with earth conductor	without earth conductor
2Cores	-	Brown,Blue
3Cores	Yellow/Green,Brown,Blue	Brown,Gray,Black
4Cores	Yellow/Green,Brown,Gray,Black	Brown,Gray,Black,Blue
5Cores	Yellow/Green,Brown,Gray,Black,Blue	Brown,Gray,Black,Blue,Black
above 5 Cores	Yellow/Green,Black Numbered	Black Numbered

Sheath Colour: Black or as order

PHYSICAL AND THERMAL PROPERTIES

Temperature range during operation: Max.90°C for XLPE
250°C in short-circuit for 5s max.

Minimum bending radius: 10x Overall Diameter

CONSTRUCTION PARAMETERS

Conductor			FTX400 1RZ1MZ1-R					
No. of Core X Cross Section	No./Nominal Diameter of Strands	Diameter Overall Conductor	Nominal Insulation Thickness	Steel Tape Thickness	Nominal Sheath Thickness	Nominal Overall Diameter	Max.DC resistance of conductor @20°C	Approx. Weight
mm ²	No/mm	mm	mm	mm	mm	mm	Ω/km	Kg/km
2x6	7/1.04	2.90	0.7	0.2	1.8	16.8	3.08	417
2x10	7/1.35	3.75	0.7	0.2	1.8	18.5	1.83	539
2x16	7/1.70	4.75	0.7	0.2	1.8	20.5	1.15	704
2x25	7/2.14	5.85	0.9	0.2	1.8	23.5	0.727	971
2x35	7/2.52	6.90	0.9	0.2	1.8	25.6	0.524	1,216
2x50	19/1.78	8.15	1.0	0.2	1.8	28.5	0.387	1,582
2x70	19/2.14	9.75	1.1	0.2	1.9	32.3	0.268	2081
2x95	19/2.52	11.45	1.1	0.2	2.0	36.4	0.193	2749
2x120	37/2.03	12.85	1.2	0.5	2.2	41.1	0.153	3,727
2x150	37/2.25	14.30	1.4	0.5	2.3	45.1	0.124	4,509



2x185	37/2.52	15.95	1.6	0.5	2.5	49.9	0.0991	5,523
2x240	61/2.25	18.25	1.7	0.5	2.6	55.3	0.0754	6981
2x300	61/2.52	20.40	1.8	0.5	2.8	60.7	0.0601	8,383
2x400	61/2.85	23.35	2.0	0.5	3.0	67.9	0.0470	10,897

ELECTRICAL PROPERTIES

Conductor Operating Temperature : 90°C

Ambient Temperature : 30°C

Current-Carrying Capacities (Amp)

Conductor cross-sectional area	Reference Method 1 (clipped direct)		Reference Method 11 (on a perforated horizontal cable tray or Reference Method 13 [free air])		In single-way ducts		Laid direct in ground	
	one 2-core cable single phase a.c. or d.c.	one 3-core or 4-core cable 3-phase a.c.	one 2-core cable single phase a.c. or d.c.	one 3-core or 4-core cable 3-phase a.c.	one 2-core cable single phase a.c. or d.c.	one 3-core or 4-core cable 3-phase a.c.	one 2-core cable single phase a.c. or d.c.	one 3-core or 4-core cable 3-phase a.c.
1	2	3	4	5	6	7	8	9
mm ²	A	A	A	A	A	A	A	A
6	62	53	66	56	-	50	-	60
10	85	73	90	78	-	65	-	80
16	110	94	115	99	115	94	140	115
25	146	124	152	131	145	125	180	150
35	180	154	188	162	175	150	215	180
50	219	187	228	197	210	175	255	215
70	279	238	291	251	260	215	315	265
95	338	289	354	304	310	260	380	315
120	392	335	410	353	355	300	430	360
150	451	386	472	406	400	335	480	405
185	515	441	539	463	455	380	540	460
240	607	520	636	546	520	440	630	530
300	698	599	732	628	590	495	700	590
400	787	673	847	728	660	560	790	670

Voltage Drop (Per Amp Per Meter)

Conductor cross-sectional area	2-core cable d.c.	2 cables, single-phase a.c.			3 or 4 cables, 3-phase a.c.			2 cables, single-phase a.c.	3 or 4 cables, 3-phase a.c.
		In ducts or in ground			In ducts or in ground			In ducts or in ground	In ducts or in ground
1	2	3			4			5	6
mm ²	mV/A/m	mV/A/m			mV/A/m			mV/A/m	mV/A/m
6	7.9	7.9			6.8			7.9	6.5
10	4.7	4.7			4.0			4.7	3.9
16	2.9	2.9			2.5			2.9	2.6
		r	x	z	r	x	z		
25	1.850	1.350	0.160	1.900	1.600	0.140	1.650	1.900	1.600
35	1.350	1.350	0.155	1.350	1.150	0.135	1.150	1.350	1.200
50	0.980	0.990	0.155	1.000	0.860	0.135	0.870	1.000	0.870
70	0.670	0.670	0.150	0.690	0.590	0.130	0.600	0.690	0.610
95	0.490	0.500	0.150	0.520	0.430	0.130	0.450	0.520	0.450
120	0.390	0.400	0.145	0.420	0.340	0.130	0.370	0.420	0.360
150	0.310	0.320	0.145	0.350	0.280	0.125	0.300	0.350	0.300
185	0.250	0.260	0.145	0.290	0.220	0.125	0.260	0.290	0.250
240	0.195	0.200	0.140	0.240	0.175	0.125	0.210	0.240	0.210
300	0.155	0.160	0.140	0.210	0.140	0.120	0.185	0.210	0.190
400	0.120	0.130	0.140	0.190	0.115	0.120	0.165	0.190	0.180

Note :

r = conductor resistance at operating temperature

x = reactance

z = impedance

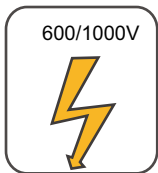

600/1000V

Rated Voltage



IEC 60502-1

Standard



Reduced Fire Propagation
NF C32-070-2.2(C1)
IEC60332-3-24/EN50266-2-4



Flame Retardancy
NF C32-070-2.1(C2)
IEC60332-1-2/EN50265-2-1

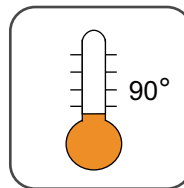

90°

Operating Temperature



Low Toxicity
NES 02-713/NF C 20-454



Low Corrosivity
IEC60754-2
EN50267-2-2/3
NF C 32-074



Low Smoke Emission
IEC 61034-1&2
EN 50268-1&2/NF C32-073

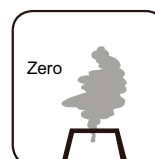

Zero

Halogen Free
IEC60754-1
EN50267-2-1



Highly Flexible



600/1000V XLPE Insulated, LSZH Sheathed, Double steel tape Armoured Power Cables (3core)

FTX400 1RZ1MZ1-R (CU/XLPE/LSZH/DSTA/LSZH 600/1000V Class 2)

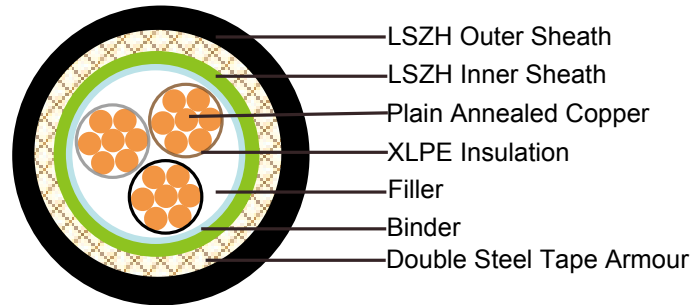

APPLICATION

The cables are mainly used in the conveyer belts, sensors, X rays, automatic sorters in the airport baggage handling system where high flexibility and heat resistance may be required. Ability to operate at high temperature protect this cables from premature aging due to constant exposure to ambient heat generated in the system, while LSZH properties assure low smoke and corrosive gas in the event of a fire.

STANDARDS

Basic design to IEC 60502-1

FIRE PERFORMANCE

Flame Retardance (Single Vertical Wire Test)	EN 60332-1-2; IEC 60332-1-2; BS EN 60332-1-2; VDE 0482-332-1 ; NBN C 30-004 (cat. F1); NF C32-070-2.1(C2); CEI 20-35/1-2; EN 50265-2-1*; DIN VDE 0482-265-2-1*
Reduced Fire Propagation (Vertically-mounted bundled wires & cable test)	EN 60332-3-24 (cat. C); IEC 60332-3-24; BS EN 60332-3-24; VDE 0482-332-3; NBN C 30-004 (cat. F2); NF C32-070-2.2(C1); CEI 20-22/3-4; EN 50266-2-4*; DIN VDE 0482-266-2-4
Halogen Free	IEC 60754-1; EN 50267-2-1; DIN VDE 0482-267-2-1; CEI 20-37/2-1 ; BS 6425-1*
No Corrosive Gas Emission	IEC 60754-2; EN 50267-2-2; DIN VDE 0482-267-2-2; CEI 20-37/2-2 ; BS 6425-2*
Minimum Smoke Emission	IEC 61034-1&2; EN 61034 -1&2; DIN VDE 0482-1034-1&2; CEI 20-37/3-1&2; EN 50268-1&2*; BS 7622-1&2*
No Toxic gases	NES 02-713; NF C 20-454

Note: Asterisk * denotes superseded standard.

VOLTAGE RATING

600/1000V

CABLE CONSTRUCTION

Conductor: Plain annealed copper wire, normal stranded or compact stranded according to IEC(EN) 60228 class 2.

Insulation: Extruded cross-linked XLPE compound.

Filler, binder and inner covering: PP, PET, LSZH

Armouring: Double steel tape

Outer Sheath: Thermoplastic LSZH compound type LTS3 as per BS 7655-6.1 (Thermosetting LSZH compound type SW2-SW4 as per BS 7655-2.6 can be offered.)

COLOUR CODE

Insulation Colour as per BS7671

	with earth conductor	without earth conductor
2Cores	-	Brown,Blue
3Cores	Yellow/Green,Brown,Blue	Brown,Gray,Black
4Cores	Yellow/Green,Brown,Gray,Black	Brown,Gray,Black,Blue
5Cores	Yellow/Green,Brown,Gray,Black,Blue	Brown,Gray,Black,Blue,Black
above 5 Cores	Yellow/Green,Black Numbered	Black Numbered

Sheath Colour: Black or as order

PHYSICAL AND THERMAL PROPERTIES

Temperature range during operation: Max.90°C for XLPE
250°C in short-circuit for 5s max.

Minimum bending radius: 10x Overall Diameter

CONSTRUCTION PARAMETERS

Conductor					FTX400 1RZ1MZ1-R					
No. of Core X Cross Section	Phases	Neutral	Nominal Diameter Overall Conductor		Nominal Insulation Thickness		Nominal Steel Tape Thickness	Nominal Sheath Thickness	Nominal Overall Diameter	Approx. Weight
	No./ Nominal Diameter of Strands	No./ Nominal Diameter of Strands	Pha.	Neu.	Pha.	Neu.				
mm ²	No/mm	No/mm	mm	mm	mm	mm	mm	mm	mm	Kg/km
3x10+1x6	7/Com	7/Com	3.75	2.90	0.7	0.7	0.2	1.8	20.1	740
3x16+1x10	7/Com	7/Com	4.75	3.75	0.7	0.7	0.2	1.8	22.5	1,004
3x25+2x16	7/Com	7/Com	5.85	4.75	0.9	0.7	0.2	1.8	25.8	1,421
3x35+1x16	7/Com	7/Com	6.90	4.75	0.9	0.7	0.2	1.8	27.7	1,745
3x35+1x25	7/Com	7/Com	6.90	5.85	0.9	0.9	0.2	1.8	28.6	1,864



3x50+1x25	7/Com	7/Com	8.15	5.85	1.0	0.9	0.2	1.8	31.3	2,358
3x50+1x35	7/Com	7/Com	8.15	6.90	1.0	0.9	0.2	1.9	32.0	2.72
3x70+1x35	19/Com	7/Com	9.75	6.90	1.1	0.9	0.2	2.0	35.9	3166
3x70+1x50	19/Com	7/Com	9.75	8.15	1.1	1.0	0.2	2.0	36.8	3.341
3x95+1x50	19/Com	7/Com	11.4	8.15	1.1	1.0	0.5	2.1	41.4	4,611
3x120+1x70	19/Com	19/Com	12.8	9.75	1.2	1.1	0.5	2.3	45.6	5682
3x150+1x95	19/Com	19/Com	14.3	11.4	1.4	1.1	0.5	2.4	50.8	7,072
3x150+1x120	19/Com	19/Com	14.3	12.8	1.4	1.2	0.5	2.5	51.8	7,357
3x185+1x95	37/Com	19/Com	15.9	11.4	1.6	1.1	0.5	2.6	54.7	8,348
3x185+1x120	37/Com	19/Com	15.9	12.8	1.6	1.2	0.5	2.6	55.8	8638
3x240+1x120	37/Com	19/Com	18.2	12.8	1.7	1.2	0.5	2.7	61.0	10,660
3x240+1x150	37/Com	19/Com	18.2	14.3	1.7	1.4	0.5	2.8	62.2	11024
3x300+1x150	37/Com	19/Com	20.4	14.3	1.8	1.4	0.5	2.9	66.8	12,809
3x300+1x185	37/Com	37/Com	20.4	15.9	1.8	1.6	0.5	3.0	68.1	13,256

Notes:

- 1) *All conductors in accordance with IEC 60228. Compact shape (Com.) or non-compact depending on order.
- 2) Beside above list we can also provide others size depend on customer's requirement.

ELECTRICAL PROPERTIES

No. of Core X Cross Section	Conductor				Max.DC resistance of conductor @20°C	
	Phases	Neutral	Dia.Overall Conductor		Pha.	Neu.
	No./Nominal Diameter of Strands	No./Nominal Diameter of Strands	Pha.	Neu.		
mm ²	No/mm	No/mm	mm	mm	Ω/km	Ω/km
3x10+1x6	7/Com	7/Com	3.75	2.90	1.83	3.08
3x16+1x10	7/Com	7/Com	4.75	3.75	1.15	1.83
3x25+2x16	7/Com	7/Com	5.85	4.75	0.727	1.15
3x35+1x16	7/Com	7/Com	6.90	4.75	0.524	1.15
3x35+1x25	7/Com	7/Com	6.90	5.85	0.524	0.727
3x50+1x25	7/Com	7/Com	8.15	5.85	0.387	0.727
3x50+1x35	7/Com	7/Com	8.15	6.90	0.387	0.524
3x70+1x35	19/Com	7/Com	9.75	6.90	0.268	0.524
3x70+1x50	19/Com	7/Com	9.75	8.15	0.268	0.387
3x95+1x50	19/Com	7/Com	11.4	8.15	0.193	0.387
3x120+1x70	19/Com	19/Com	12.8	9.75	0.153	0.268
3x150+1x95	19/Com	19/Com	14.3	11.4	0.124	0.193
3x150+1x120	19/Com	19/Com	14.3	12.8	0.124	0.153
3x185+1x95	37/Com	19/Com	15.9	11.4	0.0991	0.193

3x185+1x120	37/Com	19/Com	15.9	12.8	0.0991	0.153
3x240+1x120	37/Com	19/Com	18.2	12.8	0.0754	0.153
3x240+1x150	37/Com	19/Com	18.2	14.3	0.0754	0.124
3x300+1x150	37/Com	19/Com	20.4	14.3	0.0601	0.124
3x300+1x185	37/Com	37/Com	20.4	15.9	0.0601	0.0991

ELECTRICAL PROPERTIES

Conductor Operating Temperature : 90°C

Ambient Temperature : 30°C

Current-Carrying Capacities (Amp)

Conductor cross-sectional area	Reference Method 1 (clipped direct)		Reference Method 11 (on a perforated horizontal cable tray or Reference Method 13 [free air])		In single-way ducts		Laid direct in ground	
	one 2-core cable single phase a.c. or d.c.	one 3-core or 4-core cable 3-phase a.c.	one 2-core cable single phase a.c. or d.c.	one 3-core or 4-core cable 3-phase a.c.	one 2-core cable single phase a.c. or d.c.	one 3-core or 4-core cable 3-phase a.c.	one 2-core cable single phase a.c. or d.c.	one 3-core or 4-core cable 3-phase a.c.
1	2	3	4	5	6	7	8	9
mm ²	A	A	A	A	A	A	A	A
10	85	73	90	78	-	65	-	80
16	110	94	115	99	115	94	140	115
25	146	124	152	131	145	125	180	150
35	180	154	188	162	175	150	215	180
50	219	187	228	197	210	175	255	215
70	279	238	291	251	260	215	315	265
95	338	289	354	304	310	260	380	315
120	392	335	410	353	355	300	430	360
150	451	386	472	406	400	335	480	405
185	515	441	539	463	455	380	540	460
240	607	520	636	546	520	440	630	530
300	698	599	732	628	590	495	700	590



Voltage Drop (Per Amp Per Meter)

Conductor cross-sectional area	2-core cable d.c.	2 cables, single-phase a.c.			3 or 4 cables, 3-phase a.c.			2 cables, single-phase a.c.	3 or 4 cables, 3-phase a.c.
		In ducts or in ground			In ducts or in ground			In ducts or in ground	In ducts or in ground
1	2	3			4			5	6
mm ²	mV/A/m	mV/A/m			mV/A/m			mV/A/m	mV/A/m
6	7.9	7.9			6.8			7.9	6.5
10	4.7	4.7			4.0			4.7	3.9
16	2.9	2.9			2.5			2.9	2.6
		r	x	z	r	x	z		
25	1.850	1.350	0.160	1.900	1.600	0.140	1.650	1.900	1.600
35	1.350	1.350	0.155	1.350	1.150	0.135	1.150	1.350	1.200
50	0.980	0.990	0.155	1.000	0.860	0.135	0.870	1.000	0.870
70	0.670	0.670	0.150	0.690	0.590	0.130	0.600	0.690	0.610
95	0.490	0.500	0.150	0.520	0.430	0.130	0.450	0.520	0.450
120	0.390	0.400	0.145	0.420	0.340	0.130	0.370	0.420	0.360
150	0.310	0.320	0.145	0.350	0.280	0.125	0.300	0.350	0.300
185	0.250	0.260	0.145	0.290	0.220	0.125	0.260	0.290	0.250
240	0.195	0.200	0.140	0.240	0.175	0.125	0.210	0.240	0.210
300	0.155	0.160	0.140	0.210	0.140	0.120	0.185	0.210	0.190
400	0.120	0.130	0.140	0.190	0.115	0.120	0.165	0.190	0.180

Note :

r = conductor resistance at operating temperature

x = reactance

z = impedance

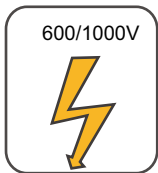

600/1000V

Rated Voltage



IEC 60502-1

Standard



Reduced Fire Propagation
NF C32-070-2.2(C1)
IEC60332-3-24/EN50266-2-4



Flame Retardancy
NF C32-070-2.1(C2)
IEC60332-1-2/EN50265-2-1

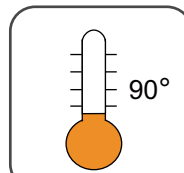

90°

Operating Temperature



Low Toxicity
NES 02-713/NF C 20-454



Low Corrosivity
IEC60754-2
EN50267-2-2/3
NF C 32-074



Low Smoke Emission
IEC 61034-1&2
EN 50268-1&2/NF C32-073

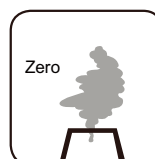

Zero

Halogen Free
IEC60754-1
EN50267-2-1



Highly Flexible

TYPE CODES FOR FIRE RETARDANT POWER & CONTROL CABLES

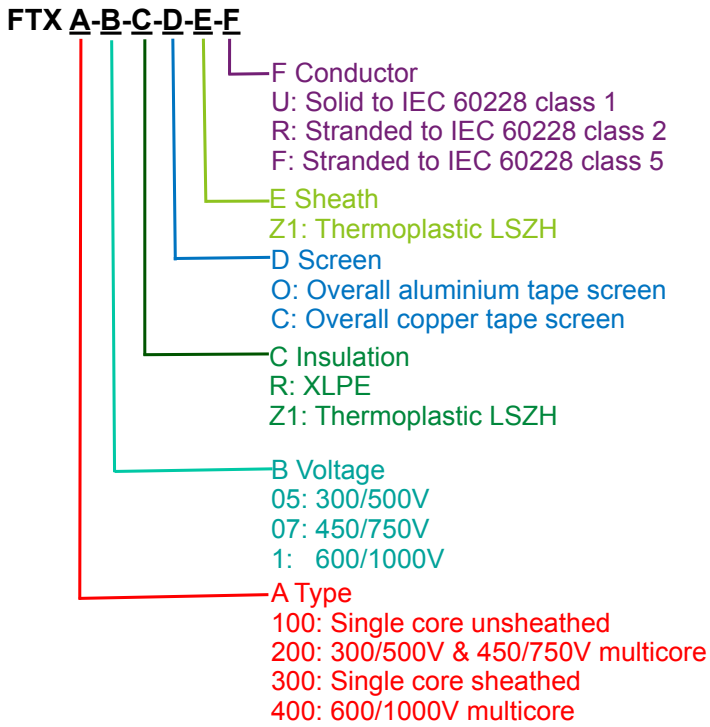



Flame Retardant Overall Screened Instrumentation Cables (multicores)

RE-2X(St)H

RE-2X(St)HSAH

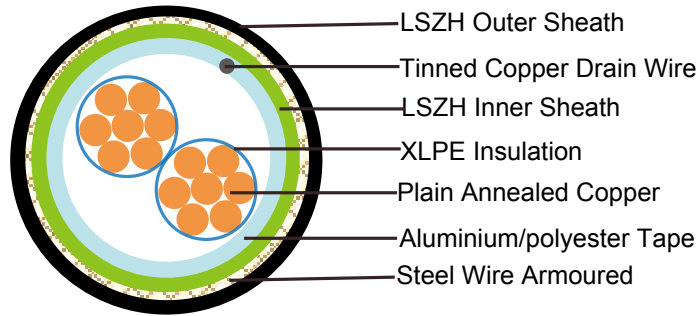

APPLICATION

The unarmoured LSZH versions (Part 1 Type 1&2) are generally use for indoor installation and suitable for wet and damp areas. Generally used within industrial process manufacturing plants for communication, data and voice transmission signals and services, Also used for the interconnection of electrical equipment and instruments, the LSZH sheath can reduce toxic smoke and fume emission. With special design for the outer jacket, the cables are flexible and are suitable for operation at high temperature, protecting this cables from premature aging, while LSZH properties assure low smoke and corrosive gas in the event of a fire.

STANDARDS

Basic design to BS 5308 Part1 Type 1 & 2

FIRE PERFORMANCE

Flame Retardance (Single Vertical Wire Test)	EN 60332-1-2; IEC 60332-1-2; BS EN 60332-1-2; VDE 0482-332-1 ; NBN C 30-004 (cat. F1); NF C32-070-2.1(C2); CEI 20-35/1-2; EN 50265-2-1*; DIN VDE 0482-265-2-1*
Reduced Fire Propagation (Vertically-mounted bundled wires & cable test)	EN 60332-3-24 (cat. C); IEC 60332-3-24; BS EN 60332-3-24; VDE 0482-332-3; NBN C 30-004 (cat. F2); NF C32-070-2.2(C1); CEI 20-22/3-4; EN 50266-2-4*; DIN VDE 0482-266-2-4
Halogen Free	IEC 60754-1; EN 50267-2-1; DIN VDE 0482-267-2-1; CEI 20-37/2-1 ; BS 6425-1*
No Corrosive Gas Emission	IEC 60754-2; EN 50267-2-2; DIN VDE 0482-267-2-2; CEI 20-37/2-2 ; BS 6425-2*
Minimum Smoke Emission	IEC 61034-1&2; EN 61034 -1&2; DIN VDE 0482-1034-1&2; CEI 20-37/3-1&2; EN 50268-1&2*; BS 7622-1&2*
No Toxic gases	NES 02-713; NF C 20-454

Note: Asterisk * denotes superseded standard.

VOLTAGE RATING

300/500V

CABLE CONSTRUCTION

Conductor: Plain annealed copper wire, stranded according to IEC(EN) 60228 class 2 and 5 .

Insulation: Extruded cross-linked XLPE compound.

Overall Screen: Aluminium/polyester tape with 0.5mm² screen (7/0.3mm) tinned copper drain wire.

Inner Sheath(optional): LSZH compound

Armouring(optional): Galvanised steel wire

Outer Sheath: Thermoplastic LSZH compound type LTS3 as per BS 7655-6.1 (Thermosetting LSZH compound type SW2-SW4 as per BS 7655-2.6 can be offered.)

COLOUR CODE

Insulation Colour as per BS7671

	with earth conductor	without earth conductor
2Cores	-	Brown,Blue
3Cores	Yellow/Green,Brown,Blue	Brown,Gray,Black
4Cores	Yellow/Green,Brown,Gray,Black	Brown,Gray,Black,Blue
5Cores	Yellow/Green,Brown,Gray,Black,Blue	Brown,Gray,Black,Blue,Black
above 5 Cores	Yellow/Green,Black Numbered	Black Numbered

Sheath Colour: Black or as order

PHYSICAL AND THERMAL PROPERTIES

Temperature range during operation: Max.90°C for XLPE
250°C in short-circuit for 5s max.

Minimum bending radius: 8 x Overall Diameter (unarmoured cable)
10 x Overall Diameter (armoured cable)

CONSTRUCTION PARAMETERS

Conductor		Nominal Insulation Thickness	RE-2X(St)H		RE-2X(St)HSAH			
No. of Core X Cross Section	No./ Nominal Diameter of Strands		Unarmoured		Armoured			
			Nominal Overall Diameter	Approx. Weight	Diameter Under Armour	Armour Wire Diameter	Nominal Overall Diameter	Approx. Weight
mm ²	No./mm	mm	mm	kg/km	mm	mm	mm	kg/km
2x0.5	16/0.20	0.6	7.0	50	7.0	0.90	11.4	237
3x0.5	16/0.20	0.6	7.3	59	7.3	0.90	11.7	254
4x0.5	16/0.20	0.6	7.9	69	7.9	0.90	12.3	278
6x0.5	16/0.20	0.6	9.3	94	9.3	0.90	13.9	345



Caledonian

Flame Retardant Instrumentation Cables

www.caledonian-cables.co.uk www.addison-cables.com



10x0.5	16/0.20	0.6	11.9	147	11.9	0.90	16.7	470
20x0.5	16/0.20	0.6	14.9	253	14.9	1.25	20.6	759
40x0.5	16/0.20	0.6	20.1	444	20.1	1.60	26.7	1229
2x0.75	24/0.20	0.6	7.3	57	7.3	0.90	11.7	251
3x0.75	24/0.20	0.6	7.7	68	7.7	0.90	12.1	272
4x0.75	24/0.20	0.6	8.3	81	8.3	0.90	12.9	310
6x0.75	24/0.20	0.6	9.9	114	9.9	0.90	14.5	379
10x0.75	24/0.20	0.6	12.7	179	12.7	0.90	17.5	522
20x0.75	24/0.20	0.6	16.0	311	16.0	1.25	21.7	858
40x0.75	24/0.20	0.6	21.7	555	21.7	1.60	28.5	1420
2x1.5	7/0.53	0.6	8.3	78	8.3	0.90	12.9	300
3x1.5	7/0.53	0.6	8.9	103	8.9	0.90	13.5	345
4x1.5	7/0.53	0.6	9.7	125	9.7	0.90	14.3	377
6x1.5	7/0.53	0.6	11.7	163	11.7	0.90	16.3	490
10x1.5	7/0.53	0.6	14.7	285	14.7	1.25	20.4	773
20x1.5	7/0.53	0.6	18.7	504	18.7	1.60	25.3	1262
40x1.5	7/0.53	0.6	24.6	935	24.6	1.60	31.6	1968

Note : Other conductor sizes & core configurations are available upon request.



300/500V

Rated Voltage



BS 5308

Standard



Reduced Fire Propagation
NF C32-070-2.2(C1)
IEC60332-3-24/EN50266-2-4



Flame Retardancy
NF C32-070-2.1(C2)

IEC60332-1-2/EN50265-2-1

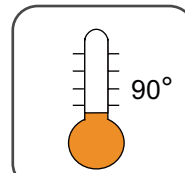

90°

Operating Temperature



Low Toxicity
NES 02-713/NF C 20-454



Low Corrosivity
IEC60754-2
EN50267-2-2/3
NF C 32-074



Low Smoke Emission
IEC 61034-1&2
EN 50268-1&2/NF C32-073

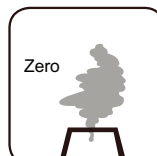

Zero
Halogen Free
IEC60754-1
EN50267-2-1



Highly Flexible

Flame Retardant Overall Screened Instrumentation Cables (multipairs)

RE-2X(St)H

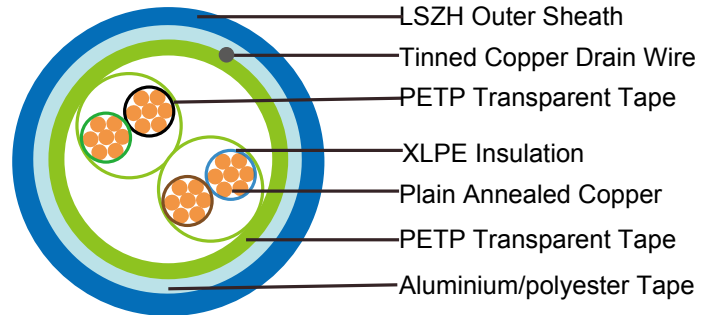

APPLICATION

The unarmoured LSZH versions (Part 1 Type 1) are generally use for indoor installation and suitable for wet and damp areas. Generally used within industrial process manufacturing plants for communication, data and voice transmission signals and services, Also used for the interconnection of electrical equipment and instruments, the LSZH sheath can reduce toxic smoke and fume emission. With special design for the outer jacket, the cables are flexible and are suitable for operation at high temperature, protecting this cables from premature aging, while LSZH properties assure low smoke and corrosive gas in the event of a fire.

STANDARDS

Basic design to BS 5308 Part 1 Type 1

FIRE PERFORMANCE

Flame Retardance (Single Vertical Wire Test)	EN 60332-1-2; IEC 60332-1-2; BS EN 60332-1-2; VDE 0482-332-1 ; NBN C 30-004 (cat. F1); NF C32-070-2.1(C2); CEI 20-35/1-2; EN 50265-2-1*; DIN VDE 0482-265-2-1*
Reduced Fire Propagation (Vertically-mounted bundled wires & cable test)	EN 60332-3-24 (cat. C); IEC 60332-3-24; BS EN 60332-3-24; VDE 0482-332-3; NBN C 30-004 (cat. F2); NF C32-070-2.2(C1); CEI 20-22/3-4; EN 50266-2-4*; DIN VDE 0482-266-2-4
Halogen Free	IEC 60754-1; EN 50267-2-1; DIN VDE 0482-267-2-1; CEI 20-37/2-1 ; BS 6425-1*
No Corrosive Gas Emission	IEC 60754-2; EN 50267-2-2; DIN VDE 0482-267-2-2; CEI 20-37/2-2 ; BS 6425-2*
Minimum Smoke Emission	IEC 61034-1&2; EN 61034 -1&2; DIN VDE 0482-1034-1&2; CEI 20-37/3-1&2; EN 50268-1&2*; BS 7622-1&2*
No Toxic gases	NES 02-713; NF C 20-454

Note: Asterisk * denotes superseded standard.



VOLTAGE RATING

300/500V

CABLE CONSTRUCTION

Conductor: Annealed or tinned copper, sizes: 0.5mm² and 0.75mm² multistranded(Class 5), 0.5 mm², 1.0 mm² solid(Class 1), 1.5mm² or 2.5mm², multistranded(Class 2) to BS6360

Insulation: XLPE (Cross Linked Polyethylene), or PE (optional)

Pairs: Two insulated conductors uniformly twisted together with a lay not exceeding 100mm

Binder tape: PETP transparent tape

Overall Screen: Aluminium/polyester tape is applied over the laid up pairs metallic side down in contact with tinned copper drain wire, 0.5mm²

Outer Sheath: Thermoplastic LSZH compound type LTS3 as per BS 7655-6.1 (Thermosetting LSZH compound type SW2-SW4 as per BS 7655-2.6 can be offered.)

COLOUR CODE

Insulation Colour: See technical information

Outer sheath: Black or blue

PHYSICAL AND THERMAL PROPERTIES

Maximum Operating temperature: -20°C - + 90°C(fixed installation)
0°C - +50°C(during operation)

Minimum bending radius: 5 x Overall Diameter

ELECTRICAL PROPERTIES

Conductor Area Size	mm ²	0.5	0.5	0.75	1.0	1.5
Conductor Stranding	No. x mm	1 x 0.8	16 x 0.2	24 x 0.2	1 x 1.13	7 x 0.53
Conductor resistance max	ohm/km	36.8	39.7	26.5	18.2	12.3
Insulation resistance min	Gohm/km	5	5	5	5	5
Capacitance unbalance at 1 kHz(pair to pair screen)	pF/250m	250				
Max. Mutual Capacitance @ 1 kHz for Non OS or OS cables (except one-pair and two-pairs)	pF/m	115	115	115	115	115
Max. Mutual Capacitance @ 1 kHz IS/OS cables (include 1 pair and 2 pair)	pF/m	75	75	75	75	75
Max. L/R Ratio for adjacent cores(Inductance/Resistance)	µH/ohm	25	25	25	25	40
Test voltage	Core to core	V	1000	1000	1000	1000
	Core to screen	V	1000	1000	1000	1000

CONSTRUCTION PARAMETERS

Conductor			RE-2X(st)H			
Number of Pairs	No./ Nominal Diameter of Strands	Nominal Conductor Cross-Section Area	Nominal Insulation Thickness	Nominal Sheath Thickness	Nominal Overall Diameter	Approx. Weight
	no./mm	mm ²	mm	mm	mm	kg/km
1	1/0.80	0.5	0.5	0.8	5.5	35
2	1/0.80	0.5	0.5	0.8	6.8	55
5	1/0.80	0.5	0.5	1.1	10.9	125
10	1/0.80	0.5	0.5	1.2	14.4	215
15	1/0.80	0.5	0.5	1.2	16.5	300
20	1/0.80	0.5	0.5	1.3	18.8	385
30	1/0.80	0.5	0.5	1.3	22.3	545
50	1/0.80	0.5	0.5	1.5	28.5	875
1	16/0.20	0.5	0.6	0.8	6.2	60
2	16/0.20	0.5	0.6	0.8	7.6	80
5	16/0.20	0.5	0.6	1.1	12.4	210
10	16/0.20	0.5	0.6	1.2	16.5	340
15	16/0.20	0.5	0.6	1.3	19.2	440
20	16/0.20	0.5	0.6	1.3	21.7	570
30	16/0.20	0.5	0.6	1.5	26.4	780
50	16/0.20	0.5	0.6	1.7	33.4	1130
1	24/0.2	0.75	0.6	0.8	6.7	75
2	24/0.2	0.75	0.6	0.9	8.4	100
5	24/0.2	0.75	0.6	1.2	13.8	250
10	24/0.2	0.75	0.6	1.3	18.4	450
15	24/0.2	0.75	0.6	1.5	21.1	600
20	24/0.2	0.75	0.6	1.5	24.4	920
30	24/0.2	0.75	0.6	1.7	29.5	980
50	24/0.2	0.75	0.6	2	37.6	1690
1	1/1.13	1	0.6	0.8	6.6	85
2	1/1.13	1	0.6	0.8	8	115
5	1/1.13	1	0.6	1.2	13.5	290
10	1/1.13	1	0.6	1.2	17.7	500
15	1/1.13	1	0.6	1.3	20.6	670



Caledonian

Flame Retardant Instrumentation Cables

www.caledonian-cables.co.uk www.addison-cables.com



Number of Pairs	Conductor		RE-2X(st)H			
	No./ Nominal Diameter of Strands	Nominal Conductor Cross-Section Area	Nominal Insulation Thickness	Nominal Sheath Thickness	Nominal Overall Diameter	Approx. Weight
	no./mm	mm ²	mm	mm	mm	kg/km
20	1/1.13	1	0.6	1.5	23.8	950
30	1/1.13	1	0.6	1.5	28.4	1030
50	1/1.13	1	0.6	2	36.6	1750
1	7/0.53	1.5	0.6	0.8	7.5	100
2	7/0.53	1.5	0.6	0.9	9.3	150
5	7/0.53	1.5	0.6	1.2	15.6	360
10	7/0.53	1.5	0.6	1.3	20.9	690
15	7/0.53	1.5	0.6	1.5	24.6	880
20	7/0.53	1.5	0.6	1.5	27.8	1230
30	7/0.53	1.5	0.6	1.7	33.7	1560
50	7/0.53	1.5	0.6	2	43	2400



300/500V

Rated Voltage



BS 5308

Standard



Reduced Fire Propagation
NF C32-070-2.2(C1)
IEC60332-3-24/EN50266-2-4



Flame Retardancy
NF C32-070-2.1(C2)
IEC60332-1-2/EN50265-2-1

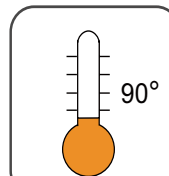

90°

Operating Temperature



Low Toxicity
NES 02-713/NF C 20-454



Low Corrosivity
IEC60754-2
EN50267-2-2/3
NF C 32-074



Low Smoke Emission
IEC 61034-1&2
EN 50268-1&2/NF C32-073

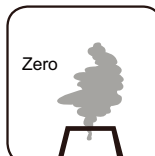

Zero

Halogen Free
IEC60754-1
EN50267-2-1



Highly Flexible

Flame Retardant Individual and Overall Screened Instrumentation Cables (multipairs)

RE-2X(St)H Pimf

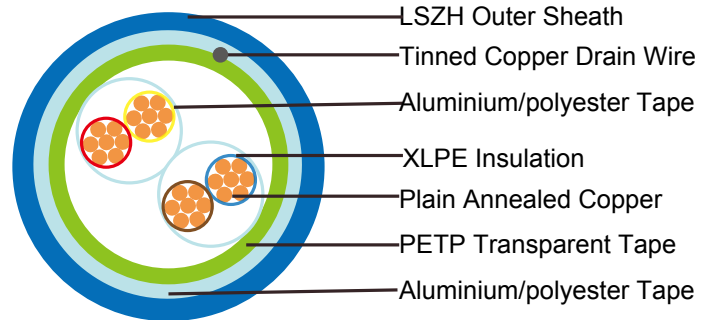

APPLICATION

The unarmoured LSZH versions (Part 1 Type 1) are generally used for indoor installation and suitable for wet and damp areas. Generally used within industrial process manufacturing plants for communication, data and voice transmission signals and services, Also used for the interconnection of electrical equipment and instruments, the LSZH sheath can reduce toxic smoke and fume emission. With special design for the outer jacket, the cables are flexible and are suitable for operation at high temperature, protecting this cables from premature aging, while LSZH properties assure low smoke and corrosive gas in the event of a fire.

STANDARDS

Basic design to BS 5308 Part 1 Type 1

FIRE PERFORMANCE

Flame Retardance (Single Vertical Wire Test)	EN 60332-1-2; IEC 60332-1-2; BS EN 60332-1-2; VDE 0482-332-1 ; NBN C 30-004 (cat. F1); NF C32-070-2.1(C2); CEI 20-35/1-2; EN 50265-2-1*; DIN VDE 0482-265-2-1*
Reduced Fire Propagation (Vertically-mounted bundled wires & cable test)	EN 60332-3-24 (cat. C); IEC 60332-3-24; BS EN 60332-3-24; VDE 0482-332-3; NBN C 30-004 (cat. F2); NF C32-070-2.2(C1); CEI 20-22/3-4; EN 50266-2-4*; DIN VDE 0482-266-2-4
Halogen Free	IEC 60754-1; EN 50267-2-1; DIN VDE 0482-267-2-1; CEI 20-37/2-1 ; BS 6425-1*
No Corrosive Gas Emission	IEC 60754-2; EN 50267-2-2; DIN VDE 0482-267-2-2; CEI 20-37/2-2 ; BS 6425-2*
Minimum Smoke Emission	IEC 61034-1&2; EN 61034 -1&2; DIN VDE 0482-1034-1&2; CEI 20-37/3-1&2; EN 50268-1&2*; BS 7622-1&2*
No Toxic gases	NES 02-713; NF C 20-454

Note: Asterisk * denotes superseded standard.



VOLTAGE RATING

300/500V

CABLE CONSTRUCTION

Conductor: Annealed or tinned copper, sizes: 0.5mm² and 0.75mm² multistranded(Class 5), 0.5 mm², 1.0 mm² solid(Class 1), 1.5mm² or 2.5mm², multistranded(Class 2) to BS6360

Insulation: XLPE (Cross Linked Polyethylene), or PE (optional)

Pairs: Two insulated conductors uniformly twisted together with a lay not exceeding 100mm

Individual Screen: Aluminium/polyester tape is applied over each pair metallic side down in contact with tinned copper drain wire, 0.5mm²

Binder tape: PETP transparent tape

Overall Screen: Aluminium/polyester tape is applied over the laid up pairs metallic side down in contact with tinned copper drain wire, 0.5mm²

Outer Sheath: Thermoplastic LSZH compound type LTS3 as per BS 7655-6.1 (Thermosetting LSZH compound type SW2-SW4 as per BS 7655-2.6 can be offered.)

COLOUR CODE

Insulation Colour as per BS7671

	with earth conductor	without earth conductor
2Cores	-	Brown,Blue
3Cores	Yellow/Green,Brown,Blue	Brown,Gray,Black
4Cores	Yellow/Green,Brown,Gray,Black	Brown,Gray,Black,Blue
5Cores	Yellow/Green,Brown,Gray,Black,Blue	Brown,Gray,Black,Blue,Black
above 5 Cores	Yellow/Green,Black Numbered	Black Numbered

Sheath Colour: Black or as order

PHYSICAL AND THERMAL PROPERTIES

Maximum Operating temperature: -20°C - + 90°C(fixed installation)
0°C - +50°C(during operation)

Minimum bending radius: 5 x Overall Diameter

ELECTRICAL PROPERTIES

Conductor Area Size	mm ²	0.5	0.5	0.75	1.0	1.5
Conductor Stranding	No. x mm	1 x 0.8	16 x 0.2	24 x 0.2	1 x 1.13	7 x 0.53
Conductor resistance max	ohm/km	36.8	39.7	26.5	18.2	12.3
Insulation resistance min	Gohm/km	5	5	5	5	5
Capacitance unbalance at 1 kHz(pair to pair screen)	pF/250m	250				

Max. Mutual Capacitance @ 1 kHz for Non OS or OS cables (except one-pair and two-pairs)		pF/m	115	115	115	115	115
Max. Mutual Capacitance @ 1 kHz IS/OS cables (include 1 pair and 2 pair)		pF/m	75	75	75	75	75
Max. L/R Ratio for adjacent cores (Inductance/Resistance)		μH/ohm	25	25	25	25	40
Test voltage	Core to core	V	1000	1000	1000	1000	1000
	Core to screen	V	1000	1000	1000	1000	1000
Rated voltage max		V	300/500	300/500	300/500	300/500	300/500

CONSTRUCTION PARAMETERS

Number of Pairs	No./Nominal Diameter of Strands	Nominal Conductor Cross-Section Area	Nominal Insulation Thickness	Nominal Sheath Thickness	Nominal Overall Diameter	Approx. Weight
	No./mm	mm ²	mm	mm	mm	kg/km
2	1/0.8	0.5	0.5	0.9	9.7	95
5	1/0.8	0.5	0.5	1.2	13	180
10	1/0.8	0.5	0.5	1.2	16.9	310
15	1/0.8	0.5	0.5	1.3	19.7	440
20	1/0.8	0.5	0.5	1.3	22.3	560
30	1/0.8	0.5	0.5	1.5	27.1	820
50	1/0.8	0.5	0.5	2	35	1370
2	16/0.2	0.5	0.6	1.1	11.2	110
5	16/0.2	0.5	0.6	1.2	14.5	250
10	16/0.2	0.5	0.6	1.3	19.3	480
15	16/0.2	0.5	0.6	1.5	22.6	570
20	16/0.2	0.5	0.6	1.5	25.7	780
30	16/0.2	0.5	0.6	1.7	31	1020
50	16/0.2	0.5	0.6	2.2	39.9	1680



Caledonian

Flame Retardant Instrumentation Cables

www.caledonian-cables.co.uk www.addison-cables.com



Number of Pairs	No./Nominal Diameter of Strands	Nominal Conductor Cross-Section Area	Nominal Insulation Thickness	Nominal Sheath Thickness	Nominal Overall Diameter	Approx. Weight
	No./mm	mm ²	mm	mm	mm	kg/km
2	1/1.13	1	0.6	1.1	11.9	200
5	1/1.13	1	0.6	1.2	15.4	290
10	1/1.13	1	0.6	1.3	20.5	580
15	1/1.13	1	0.6	1.5	24.1	780
20	1/1.13	1	0.6	1.7	27.7	1010
30	1/1.13	1	0.6	2	33.7	1430
50	1/1.13	1	0.6	2.2	42.5	2360
2	7/0.53	1.5	0.6	1.2	13.6	250
5	7/0.53	1.5	0.6	1.3	17.7	460
10	7/0.53	1.5	0.6	1.5	23.9	760
15	7/0.53	1.5	0.6	1.7	28	1020
20	7/0.53	1.5	0.6	2	31.7	1350
30	7/0.53	1.5	0.6	2.2	38.6	1900
50	7/0.53	1.5	0.6	2.2	48.9	3060



300/500V

Rated Voltage



BS 5308

Standard



Reduced Fire Propagation
NF C32-070-2.2(C1)
IEC60332-3-24/EN50266-2-4



Flame Retardancy
NF C32-070-2.1(C2)
IEC60332-1-2/EN50265-2-1

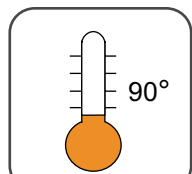

90°

Operating Temperature



Low Toxicity
NES 02-713/NF C 20-454



Low Corrosivity
IEC60754-2
EN50267-2-2/3
NF C 32-074



Low Smoke Emission
IEC 61034-1&2
EN 50268-1&2/NF C32-073

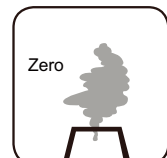

Zero

Halogen Free
IEC60754-1
EN50267-2-1



Highly Flexible

Flame Retardant Overall Screened, Armoured Instrumentation Cables (multipairs)

RE-2X(St)HSAH

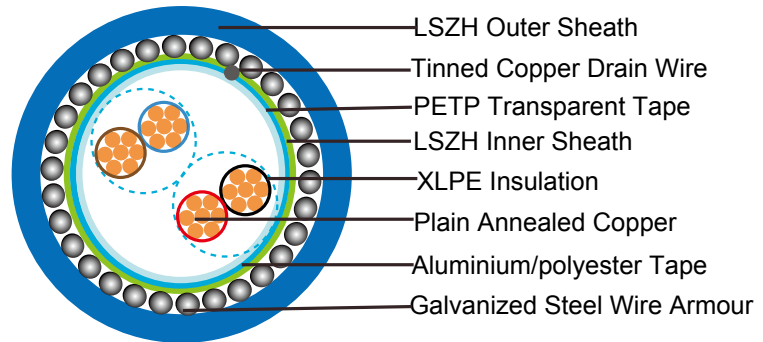
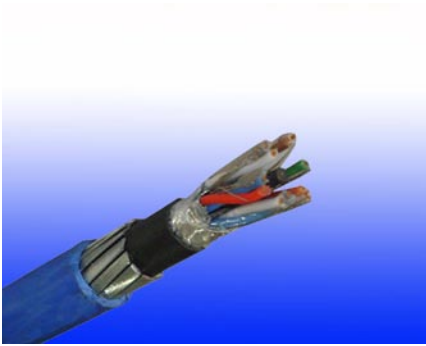

APPLICATION

The armoured LSZH versions (Part 1 Type 2) are generally used when the risk of mechanical damage is increased. The galvanized steel wire armour provides excellent protection. Generally used within industrial process manufacturing plants for communication, data and voice transmission signals and services, Also used for the interconnection of electrical equipment and instruments, the LSZH sheath can reduce toxic smoke and fume emission. With special design for the outer jacket, the cables are flexible and are suitable for operation at high temperature, protecting this cables from premature aging, while LSZH properties assure low smoke and corrosive gas in the event of a fire.

STANDARDS

Basic design to BS 5308 Part 1 Type 2

FIRE PERFORMANCE

Flame Retardance (Single Vertical Wire Test)	EN 60332-1-2; IEC 60332-1-2; BS EN 60332-1-2; VDE 0482-332-1 ; NBN C 30-004 (cat. F1); NF C32-070-2.1(C2); CEI 20-35/1-2; EN 50265-2-1*; DIN VDE 0482-265-2-1*
Reduced Fire Propagation (Vertically-mounted bundled wires & cable test)	EN 60332-3-24 (cat. C); IEC 60332-3-24; BS EN 60332-3-24; VDE 0482-332-3; NBN C 30-004 (cat. F2); NF C32-070-2.2(C1); CEI 20-22/3-4; EN 50266-2-4*; DIN VDE 0482-266-2-4
Halogen Free	IEC 60754-1; EN 50267-2-1; DIN VDE 0482-267-2-1; CEI 20-37/2-1 ; BS 6425-1*
No Corrosive Gas Emission	IEC 60754-2; EN 50267-2-2; DIN VDE 0482-267-2-2; CEI 20-37/2-2 ; BS 6425-2*
Minimum Smoke Emission	IEC 61034-1&2; EN 61034 -1&2; DIN VDE 0482-1034-1&2; CEI 20-37/3-1&2; EN 50268-1&2*; BS 7622-1&2*
No Toxic gases	NES 02-713; NF C 20-454

Note: Asterisk * denotes superseded standard.



VOLTAGE RATING

300/500V

CABLE CONSTRUCTION

Conductor: Annealed or tinned copper, sizes: 0.5mm² and 0.75mm² multistranded(Class 5), 0.5 mm², 1.0 mm² solid(Class 1), 1.5mm² or 2.5mm², multistranded(Class 2) to BS6360

Insulation: XLPE (Cross Linked Polyethylene), or PE (optional)

Pairs: Two insulated conductors uniformly twisted together with a lay not exceeding 100mm

Binder tape: PETP transparent tape

Overall Screen: Aluminium/polyester tape is applied over the laid up pairs metallic side down in contact with tinned copper drain wire, 0.5mm²

Inner Sheath: LSOH(Low Smoke Zero Halogen) sheath

Armouring: Galvanized steel wire armour

Outer Sheath: Thermoplastic LSZH compound type LTS3 as per BS 7655-6.1 (Thermosetting LSZH compound type SW2-SW4 as per BS 7655-2.6 can be offered.)

COLOUR CODE

Insulation Colour as per BS7671

	with earth conductor	without earth conductor
2Cores	-	Brown,Blue
3Cores	Yellow/Green,Brown,Blue	Brown,Gray,Black
4Cores	Yellow/Green,Brown,Gray,Black	Brown,Gray,Black,Blue
5Cores	Yellow/Green,Brown,Gray,Black,Blue	Brown,Gray,Black,Blue,Black
above 5 Cores	Yellow/Green,Black Numbered	Black Numbered

Sheath Colour: Black or as order

PHYSICAL AND THERMAL PROPERTIES

Maximum Operating temperature: -20°C - + 90°C(fixed installation)
0°C -+50°C(during operation)

Minimum bending radius: 6 x Overall Diameter

ELECTRICAL PROPERTIES

Conductor Area Size	mm ²	0.5	0.5	0.75	1.0	1.5
Conductor Stranding	No. x mm	1 x 0.8	16 x 0.2	24 x 0.2	1 x 1.13	7 x 0.53
Conductor resistance max	ohm/km	36.8	39.7	26.5	18.2	12.3
Insulation resistance min	Gohm/km	5	5	5	5	5
Capacitance unbalance at 1 kHz(pair to pair screen)	pF/250m	250				
Max. Mutual Capacitance @ 1 kHz for Non OS or OS cables (except one-pair and two-pairs)	pF/m	115	115	115	115	120

Max. Mutual Capacitance @ 1 kHz IS/OS cables (include 1 pair and 2 pair)		pF/m	75	75	75	75	85
Max. L/R Ratio for adjacent cores(Inductance/Resistance)		μH/ohm	25	25	25	25	40
Test voltage	Core to core	V	1000	1000	1000	1000	1000
	Core to screen	V	1000	1000	1000	1000	1000
Rated voltage max		V	300/500	300/500	300/500	300/500	300/500

CONSTRUCTION PARAMETERS

Number of Pairs	No./Nominal Diameter of Strands	Nominal Conductor Cross-Section Area	Nominal Insulation Thickness	Nominal Sheath Thickness	Nominal Overall Diameter	Approx. Weight	Nominal Thickness of Sheath	Nominal Dia. of Cable	Approx. Weight
	no./mm	mm ²	mm	mm	mm	kg/km	mm	mm	kg/km
1	1/0.80	0.5	0.5	0.8	5.5	0.9	1.3	9.9	200
2	1/0.80	0.5	0.5	0.8	6.8	0.9	1.3	11.2	260
5	1/0.80	0.5	0.5	1.1	10.9	0.9	1.4	15.5	460
10	1/0.80	0.5	0.5	1.2	14.4	1.25	1.6	20.1	790
15	1/0.80	0.5	0.5	1.2	16.5	1.25	1.6	22.2	1100
20	1/0.80	0.5	0.5	1.3	18.8	1.6	1.7	25.4	1280
30	1/0.80	0.5	0.5	1.3	22.3	1.6	1.8	29.1	1520
50	1/0.80	0.5	0.5	1.5	28.5	1.6	2	35.7	2100
1	16/0.2	0.5	0.6	0.8	6.2	0.9	1.3	10.6	250
2	16/0.2	0.5	0.6	0.8	7.6	0.9	1.3	12	300
5	16/0.2	0.5	0.6	1.1	12.4	0.9	1.5	17.2	560
10	16/0.2	0.5	0.6	1.2	16.5	1.25	1.6	22.2	970
15	16/0.2	0.5	0.6	1.3	19.2	1.6	1.7	25.8	1240
20	16/0.2	0.5	0.6	1.3	21.7	1.6	1.8	28.5	1640
30	16/0.2	0.5	0.6	1.5	26.4	1.6	1.9	33.4	1770
50	16/0.2	0.5	0.6	1.7	33.4	2	2.1	41.6	2770
1	24/0.2	0.75	0.6	0.8	6.7	0.9	1.4	10.9	280
2	24/0.2	0.75	0.6	0.9	8.4	0.9	1.4	12.8	330
5	24/0.2	0.75	0.6	1.2	13.8	1.25	1.6	19.3	750
10	24/0.2	0.75	0.6	1.3	18.4	1.6	1.8	24.3	1260
15	24/0.2	0.75	0.6	1.3	21.1	1.6	1.9	27	1480
20	24/0.2	0.75	0.6	1.5	24.4	1.6	2	31.4	1890



Caledonian

Flame Retardant Instrumentation Cables

www.caledonian-cables.co.uk www.addison-cables.com



Number of Pairs	No./Nominal Diameter of Strands	Nominal Conductor Cross-Section Area	Nominal Insulation Thickness	Nominal Sheath Thickness	Nominal Overall Diameter	Approx. Weight	Nominal Thickness of Sheath	Nominal Dia. of Cable	Approx. Weight
	no./mm	mm ²	mm	mm	mm	kg/km	mm	mm	kg/km
30	24/0.2	0.75	0.6	1.7	29.5	2	2.1	37	2440
50	24/0.2	0.75	0.6	2	37.6	2.5	2.4	47.3	3210
1	1/1.13	1	0.6	0.8	6.6	0.9	1.3	11	290
2	1/1.13	1	0.6	0.8	8	0.9	1.4	12.6	345
5	1/1.13	1	0.6	1.2	13.5	1.25	1.5	19	790
10	1/1.13	1	0.6	1.2	17.7	1.25	1.7	23.6	1310
15	1/1.13	1	0.6	1.3	20.6	1.6	1.8	27.4	1740
20	1/1.13	1	0.6	1.5	23.8	1.6	1.8	30.6	2040
30	1/1.13	1	0.6	1.5	28.4	1.6	2	35.6	2180
50	1/1.13	1	0.6	2	36.6	2	2.2	45	3500
1	7/0.53	1.5	0.6	0.8	7.5	0.9	1.4	11.9	320
2	7/0.53	1.5	0.6	0.9	9.3	0.9	1.5	14.1	420
5	7/0.53	1.5	0.6	1.2	15.6	1.25	1.6	21.6	940
10	7/0.53	1.5	0.6	1.3	20.9	1.6	1.8	27.4	1500
15	7/0.53	1.5	0.6	1.5	24.6	1.6	1.9	31.2	1970
20	7/0.53	1.5	0.6	1.5	27.8	1.6	2	35.8	2400
30	7/0.53	1.5	0.6	1.7	33.7	2	2.2	42.3	3170
50	7/0.53	1.5	0.6	2	43	2.5	2.5	53.2	5020



300/500V

Rated Voltage



BS 5308

Standard



Reduced Fire Propagation
NF C32-070-2.2(C1)
IEC60332-3-24/EN50266-2-4



Flame Retardancy
NF C32-070-2.1(C2)
IEC60332-1-2/EN50265-2-1

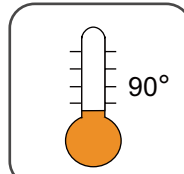

90°

Operating Temperature



Low Toxicity
NES 02-713/NF C 20-454



Low Corrosivity
IEC60754-2
EN50267-2-2/3
NF C 32-074



Low Smoke Emission
IEC 61034-1&2
EN 50268-1&2/NF C32-073

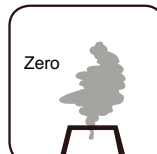

Zero

Halogen Free
IEC60754-1
EN50267-2-1



Highly Flexible

Flame Retardant Individual and Overall Screened, Armoured Instrumentation Cables (multipairs)

RE-2X(St)HSWAH Pimf

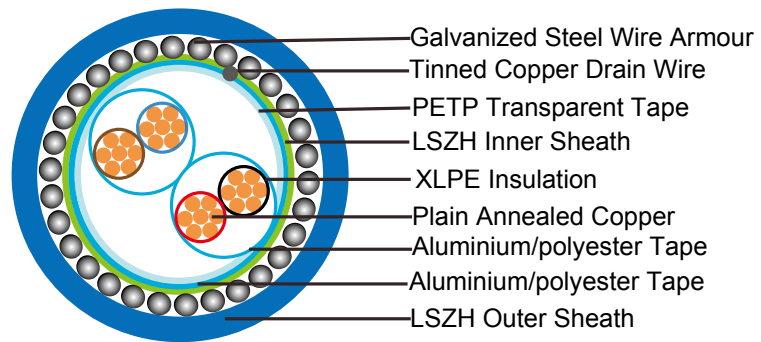

APPLICATION

The armoured LSZH versions (Part 1 Type 2) are generally used when the risk of mechanical damage is increased. The galvanized steel wire armour provides excellent protection. Generally used within industrial process manufacturing plants for communication, data and voice transmission signals and services, Also used for the interconnection of electrical equipment and instruments, the LSZH sheath can reduce toxic smoke and fume emission. With special design for the outer jacket, the cables are flexible and are suitable for operation at high temperature, protecting this cables from premature aging, while LSZH properties assure low smoke and corrosive gas in the event of a fire.

STANDARDS

Basic design to BS 5308 Part 1 Type 2

FIRE PERFORMANCE

Flame Retardance (Single Vertical Wire Test)	EN 60332-1-2; IEC 60332-1-2; BS EN 60332-1-2; VDE 0482-332-1 ; NBN C 30-004 (cat. F1); NF C32-070-2.1(C2); CEI 20-35/1-2; EN 50265-2-1*; DIN VDE 0482-265-2-1*
Reduced Fire Propagation (Vertically-mounted bundled wires & cable test)	EN 60332-3-24 (cat. C); IEC 60332-3-24; BS EN 60332-3-24; VDE 0482-332-3; NBN C 30-004 (cat. F2); NF C32-070-2.2(C1); CEI 20-22/3-4; EN 50266-2-4*; DIN VDE 0482-266-2-4
Halogen Free	IEC 60754-1; EN 50267-2-1; DIN VDE 0482-267-2-1; CEI 20-37/2-1 ; BS 6425-1*
No Corrosive Gas Emission	IEC 60754-2; EN 50267-2-2; DIN VDE 0482-267-2-2; CEI 20-37/2-2 ; BS 6425-2*
Minimum Smoke Emission	IEC 61034-1&2; EN 61034 -1&2; DIN VDE 0482-1034-1&2; CEI 20-37/3-1&2; EN 50268-1&2*; BS 7622-1&2*
No Toxic gases	NES 02-713; NF C 20-454

Note: Asterisk * denotes superseded standard.



VOLTAGE RATING

300/500V

CABLE CONSTRUCTION

Conductor: Annealed or tinned copper, sizes: 0.5mm² and 0.75mm² multistranded(Class 5), 0.5 mm², 1.0 mm² solid(Class 1), 1.5mm² or 2.5mm², multistranded(Class 2) to BS6360

Insulation: XLPE (Cross Linked Polyethylene), or PE (optional)

Pairs: Two insulated conductors uniformly twisted together with a lay not exceeding 100mm

Individual Screen: Aluminium/polyester tape is applied over the laid up pairs metallic side down in contact with tinned copper drain wire, 0.5mm²

Binder tape: PETP transparent tape

Overall Screen: Aluminium/polyester tape is applied over the laid up pairs metallic side down in contact with tinned copper drain wire, 0.5mm²

Inner Sheath: LSOH(Low Smoke Zero Halogen) sheath

Armouring: Galvanized steel wire armour

Outer Sheath: Thermoplastic LSZH compound type LTS3 as per BS 7655-6.1 (Thermosetting LSZH compound type SW2-SW4 as per BS 7655-2.6 can be offered.)

COLOUR CODE

Insulation Colour as per BS7671

	with earth conductor	without earth conductor
2Cores	-	Brown,Blue
3Cores	Yellow/Green,Brown,Blue	Brown,Gray,Black
4Cores	Yellow/Green,Brown,Gray,Black	Brown,Gray,Black,Blue
5Cores	Yellow/Green,Brown,Gray,Black,Blue	Brown,Gray,Black,Blue,Black
above 5 Cores	Yellow/Green,Black Numbered	Black Numbered

Sheath Colour: Black or as order

PHYSICAL AND THERMAL PROPERTIES

Maximum Operating temperature: -30°C - + 90°C(fixed installation)
0°C - +50°C(during operation)

Minimum bending radius: 6 x Overall Diameter

ELECTRICAL PROPERTIES

Conductor Area Size	mm ²	0.5	0.5	0.75	1.0	1.5
Conductor Stranding	No. x mm	1 x 0.8	16 x 0.2	24 x 0.2	1 x 1.13	7 x 0.53
Conductor resistance max	ohm/km	36.8	39.7	26.5	18.2	12.3
Insulation resistance min	Gohm/km	5	5	5	5	5
Capacitance unbalance at 1 kHz(pair to pair screen)	pF/250m	250				

Max. Mutual Capacitance @ 1 kHz for Non OS or OS cables (except one-pair and two-pairs)		pF/m	115	115	115	115	120
Max. Mutual Capacitance @ 1 kHz IS/OS cables (include 1 pair and 2 pair)		pF/m	75	75	75	75	85
Max. L/R Ratio for adjacent cores (Inductance/Resistance)		μH/ohm	25	25	25	25	40
Test voltage	Core to core	V	1000	1000	1000	1000	1000
	Core to screen	V	1000	1000	1000	1000	1000
Rated voltage max		V	300/500	300/500	300/500	300/500	300/500

CONSTRUCTION PARAMETERS

No. of Pairs	No./ Nominal Diameter of Strands	Nominal Conductor Cross-Section Area	Nominal Insulation Thickness	Nominal Inner Sheath Thickness	Nominal Diameter Overall Inner Sheath	Nominal Armour Thickness	Nominal Sheath Thickness	Nominal Overall Diameter	Approx. Weight
	no./mm	mm ²	mm	mm	mm	mm	mm	mm	kg/km
2	1/0.80	0.5	0.5	0.9	9.7	0.9	1.4	14.3	380
5	1/0.80	0.5	0.5	1.2	13	1.25	1.5	18.5	640
10	1/0.80	0.5	0.5	1.2	16.9	1.25	1.7	22.8	890
15	1/0.80	0.5	0.5	1.3	19.7	1.6	1.7	26.3	1350
20	1/0.80	0.5	0.5	1.3	22.3	1.6	1.8	29.1	1470
30	1/0.80	0.5	0.5	1.5	27.1	1.6	1.9	34.1	1870
50	1/0.80	0.5	0.5	2	35	2	2.2	43.4	3000
2	16/0.2	0.5	0.6	1.1	11.2	0.9	1.5	16	460
5	16/0.2	0.5	0.6	1.2	14.5	1.25	1.6	20.2	760
10	16/0.2	0.5	0.6	1.3	19.3	1.6	1.8	26.1	1300
15	16/0.2	0.5	0.6	1.5	22.6	1.6	1.8	29.4	1440
20	16/0.2	0.5	0.6	1.5	25.7	1.6	1.9	32.7	1870
30	16/0.2	0.5	0.6	1.7	31	2	2.1	39.2	2400
50	16/0.2	0.5	0.6	2.2	39.9	2.5	2.4	49.7	3930
2	24/0.2	0.75	0.6	1.1	12.1	0.9	1.5	16.9	500
5	24/0.2	0.75	0.6	1.2	15.7	1.25	1.6	21.4	920
10	24/0.2	0.75	0.6	1.3	20.9	1.6	1.7	27.5	1610
15	24/0.2	0.75	0.6	1.5	24.6	1.6	1.9	31.6	1960



Caledonian

Flame Retardant Instrumentation Cables

www.caledonian-cables.co.uk www.addison-cables.com



No. of Pairs	No. / Nominal Diameter of Strands	Nominal Conductor Cross-Section Area	Nominal Insulation Thickness	Nominal Inner Sheath Thickness	Nominal Diameter Overall Inner Sheath	Nominal Armour Thickness	Nominal Sheath Thickness	Nominal Overall Diameter	Approx. Weight
	no./mm	mm ²	mm	mm	mm	mm	mm	mm	kg/km
20	24/0.2	0.75	0.6	1.5	27.9	1.6	1.9	34.9	2420
30	24/0.2	0.75	0.6	2	34.4	2	2.2	42.8	3180
50	24/0.2	0.75	0.6	2.2	43.5	2.5	2.5	53.5	4506
2	1/1.13	1	0.6	1.1	11.9	0.9	1.5	16.7	515
5	1/1.13	1	0.6	1.2	15.4	1.25	1.6	21.1	950
10	1/1.13	1	0.6	1.3	20.5	1.6	1.8	27.3	1330
15	1/1.13	1	0.6	1.5	24.1	1.6	1.9	31.1	1680
20	1/1.13	1	0.6	1.7	27.7	2	2	35.7	2540
30	1/1.13	1	0.6	2	33.7	2	2.2	42.1	2900
50	1/1.13	1	0.6	2.2	42.5	2.5	2.5	52.5	4800
2	7/0.53	1.5	0.6	1.2	13.6	1.25	1.6	19.3	730
5	7/0.53	1.5	0.6	1.3	17.7	1.6	1.7	24.3	1180
10	7/0.53	1.5	0.6	1.5	23.9	1.6	1.9	30.9	1820
15	7/0.53	1.5	0.6	1.7	28	2	2	36	2350
20	7/0.53	1.5	0.6	1.7	31.7	2	2.1	39.9	3030
30	7/0.53	1.5	0.6	2	38.6	2	2.5	48.6	4050
50	7/0.53	1.5	0.6	2.2	48.9	2	2.7	59.3	5960



300/500V

Rated Voltage



BS 5308

Standard



Reduced Fire Propagation
NF C32-070-2.2(C1)
IEC60332-3-24/EN50266-2-4



Flame Retardancy
NF C32-070-2.1(C2)
IEC60332-1-2/EN50265-2-1

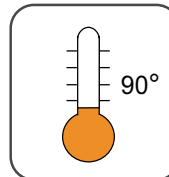

90°

Operating Temperature



Low Toxicity
NES 02-713/NF C 20-454



Low Corrosivity
IEC60754-2
EN50267-2-2/3
NF C 32-074



Low Smoke Emission
IEC 61034-1&2
EN 50268-1&2/NF C32-073

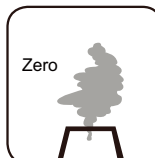

Zero

Halogen Free
IEC60754-1
EN50267-2-1



Highly Flexible



Instrument Cables BS 5308 Part 1 Colour Code

BS 5308 Part 1 Colour Identification

Pair No.	a-wire	b-wire	Pair No.	a-wire	b-wire
1	Black	Blue	26	White	Yellow
2	Black	Green	27	Red	Yellow
3	Blue	Green	28	Orange	Yellow
4	Black	Brown	29	Black	Grey
5	Blue	Brown	30	Blue	Grey
6	Green	Brown	31	Green	Grey
7	Black	White	32	Brown	Grey
8	Blue	White	33	White	Grey
9	Green	White	34	Red	Grey
10	Brown	White	35	Orange	Grey
11	Black	Red	36	Yellow	Grey
12	Blue	Red	37	Black	Violet
13	Green	Red	38	Blue	Violet
14	Brown	Red	39	Green	Violet
15	White	Red	40	Brown	Violet
16	Black	Orange	41	White	Violet
17	Blue	Orange	42	Red	Violet
18	Green	Orange	43	Orange	Violet
19	Brown	Orange	44	Yellow	Violet
20	White	Orange	45	Grey	Violet
21	Red	Orange	46	Black	Turquoise
22	Black	Yellow	47	Blue	Turquoise
23	Blue	Yellow	48	Green	Turquoise
24	Green	Yellow	49	Brown	Turquoise
25	Brown	Yellow	50	White	Turquoise

Single Quad (2 pair) are colour coded in clockwise order of rotation: Black, Blue, Green and Brown
 Individually screened pairs can also be identified by means of a polyester tape over blue and black pairs

For cables in triple configuration please request colour code at time of enquiry
 Instrument Cables BS 5308 Part 2 Colour code



BS 5308 Part 2 Colour Identification

Pair No.	a-wire		b-wire	Pair No.	a-wire		b-wire
1	White		Blue	26	Red	Blue	Blue
2	White		Orange	27	Red	Blue	Orange
3	White		Green	28	Red	Blue	Green
4	White		Brown	29	Red	Blue	Brown
5	White		Grey	30	Red	Blue	Grey
6	Red		Blue	31	Blue	Black	Blue
7	Red		Orange	32	Blue	Black	Orange
8	Red		Green	33	Blue	Black	Green
9	Red		Brown	34	Blue	Black	Brown
10	Red		Grey	35	Blue	Black	Grey
11	Black		Blue	36	Yellow	Blue	Blue
12	Black		Orange	37	Yellow	Blue	Orange
13	Black		Green	38	Yellow	Blue	Green
14	Black		Brown	39	Yellow	Blue	Brown
15	Black		Grey	40	Yellow	Blue	Grey
16	Yellow		Blue	41	White	Orange	Blue
17	Yellow		Orange	42	White	Orange	Orange
18	Yellow		Green	43	White	Orange	Green
19	Yellow		Brown	44	White	Orange	Brown
20	Yellow		Grey	45	White	Orange	Grey
21	White	Blue	Blue	46	Orange	Red	Blue
22	White	Blue	Orange	47	Orange	Red	Orange
23	White	Blue	Green	48	Orange	Red	Green
24	White	Blue	Brown	49	Orange	Red	Brown
25	White	Blue	Grey	50	Orange	Red	Grey

*For bi- coloured cores the first colour is the base colour

Single Quad (2 pair) are colour coded in clockwise order of rotation: Black, Blue, Green and Brown
Individually screened pairs can also be identified by means of a polyester tape over blue and black pairs

For cables in triple configuration please request colour code at time of enquiry

Flame Retardant CAT5E Data Cables

FTX-CAT5E U/UTP4P24
 FTX-CAT5E F/UTP4P24
 FTX-CAT5E SF/UTP4P24

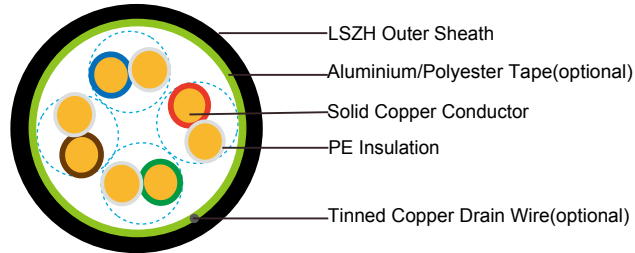
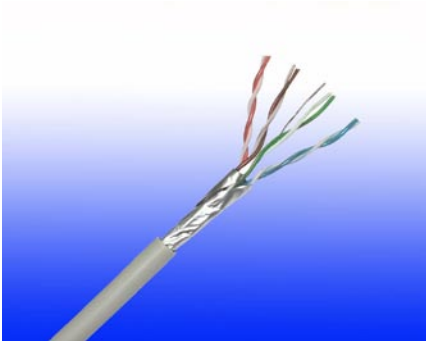

APPLICATION

Cat5E is a cable standard for Gigabit Ethernet and other network protocol, suitable for basic voice and data installations up to 100 MHz. In addition, these cables can be offered with copper wire braid armoured & flame retardant outer sheath, providing additional mechanically protection still maintaining the flexibility of the cable. With special design for the outer jacket, the cables are flexible and are suitable for operation at high temperature, protecting this cables from premature aging, while LSZH properties assure low smoke and corrosive gas in the event of a fire.

STANDARDS

Basic design to EN50173

FIRE PERFORMANCE

Flame Retardance (Single Vertical Wire Test)	EN 60332-1-2; IEC 60332-1-2; BS EN 60332-1-2; VDE 0482-332-1 ; NBN C 30-004 (cat. F1); NF C32-070-2.1(C2); CEI 20-35/1-2; EN 50265-2-1*; DIN VDE 0482-265-2-1*
Reduced Fire Propagation (Vertically-mounted bundled wires & cable test)	EN 60332-3-24 (cat. C); IEC 60332-3-24; BS EN 60332-3-24; VDE 0482-332-3; NBN C 30-004 (cat. F2); NF C32-070-2.2(C1); CEI 20-22/3-4; EN 50266-2-4*; DIN VDE 0482-266-2-4
Halogen Free	IEC 60754-1; EN 50267-2-1; DIN VDE 0482-267-2-1; CEI 20-37/2-1 ; BS 6425-1*
No Corrosive Gas Emission	IEC 60754-2; EN 50267-2-2; DIN VDE 0482-267-2-2; CEI 20-37/2-2 ; BS 6425-2*
Minimum Smoke Emission	IEC 61034-1&2; EN 61034 -1&2; DIN VDE 0482-1034-1&2; CEI 20-37/3-1&2; EN 50268-1&2*; BS 7622-1&2*
No Toxic gases	NES 02-713; NF C 20-454

Note: Asterisk * denotes superseded standard.

VOLTAGE RATING

60V



CABLE CONSTRUCTION

Conductors: 24AWG solid bare copper.

Insulation: HDPE.

Twinning: Two coloured insulated conductors twisted together to form a pair.

Outer Sheath: Thermoplastic LSZH compound type LTS3 as per BS 7655-6.1 (Thermosetting LSZH compound type SW2-SW4 as per BS 7655:section 2.6 can be offered.)

Cat5E F/UTP: These cables have collective shielding of aluminium/Polyester tape with drain wire.

Cat5E SF/UTP: These cables have double collective shieldings of aluminium/Polyester tape & copper wire braid.

PHYSICAL AND THERMAL PROPERTIES

Temperature range: -30°C ~ +90°C

Minimum bending radius during installation (mobile state): 8 x Overall Diameter

Minimum bending radius during operation (fixed state): 4 x Overall Diameter

ELECTRICAL PROPERTIES

AWG		24
Nominal Conductor Diameter	mm	0.5/0.53
Maximum DC Resistant@20°C	Ω/100m	9.38
Maximum DCR Unbalance	%	5
Maximum Mutual Capacitance	pF/m	55.8
Maximum Capacitance Unbalance	pF/100m	330
Characteristic Impedance@1-100MHz	Ω	100+/-15
Maximum Propagation Delay Skew	ns/100m	45

TRANSMISSION PROPERTIES

FREQ MHz	Maximum Attenuation dB/100m	Minimum NEXT dB	Minimum PSNEXT dB	Minimum ELFEXT dB/100m	Minimum PSELFEXT dB/100m	Minimum RL dB
0.772	1.8	67.0	64.0	66.0	63.0	—
1	2.0	65.3	62.3	63.8	60.8	20.0
4	4.1	56.3	53.3	51.7	48.7	23.0
8	5.8	51.8	48.8	45.7	42.7	24.5
10	6.5	50.3	47.3	43.8	40.8	25.0
16	8.2	47.3	44.3	39.7	36.7	25.0
20	9.3	45.8	42.8	37.7	34.7	25.0
25	10.4	44.3	41.3	35.8	32.8	24.3
31.25	11.7	42.9	39.9	33.9	30.9	23.6
62.5	17.0	38.4	35.4	27.8	24.8	21.5

FREQ MHz	Maximum Attenuation dB/100m	Minimum NEXT dB	Minimum PSNEXT dB	Minimum ELFEXT dB/100m	Minimum PSELFEXT dB/100m	Minimum RL dB
100	22.0	35.3	32.3	23.8	20.8	20.1

CONSTRUCTION PARAMETERS

Cable Code	Conductor Diameter	Diameter Over Insulation	Pairs	Screen	Nominal Overall Diameter
	mm	mm			mm
Cat5E U/UTP	0.5	0.91	4	Nil	5.1
Cat5E F/UTP	0.53	1.00	4	Overall Aluminum Tape Screen	6.3
Cat5E SF/UTP	0.53	1.00	4	Overall Aluminum Tape Screen & Copper Wire Braid	6.6



Rated Voltage



Standard



Reduced Fire Propagation
NF C32-070-2.2(C1)
IEC60332-3-24/EN50266-2-4



Flame Retardancy
NF C32-070-2.1(C2)
IEC60332-1-2/EN50265-2-1

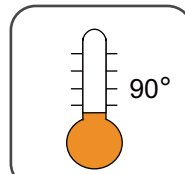

Operating Temperature



Low Toxicity
NES 02-713/NF C 20-454



Low Corrosivity
IEC60754-2
EN50267-2-2/3
NF C 32-074



Low Smoke Emission
IEC 61034-1&2
EN 50268-1&2/NF C32-073

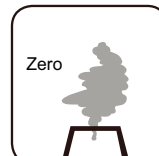

Zero
Halogen Free
IEC60754-1
EN50267-2-1



Highly Flexible



Flame Retardant CAT5E CWB/SWB/SWA Armoured Data Cables

FTX-CAT5E U/UTP4P24 CWB/SWB/SWA
FTX-CAT5E F/UTP4P24 CWB/SWB/SWA
FTX-CAT5E SF/FTP4P24 CWB/SWB/SWA

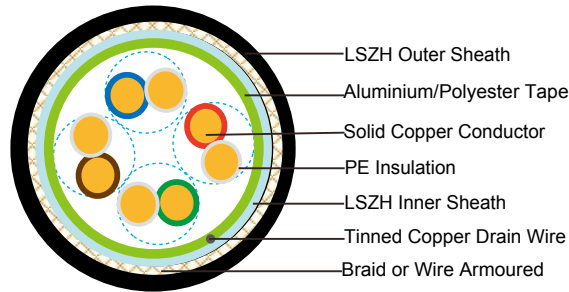
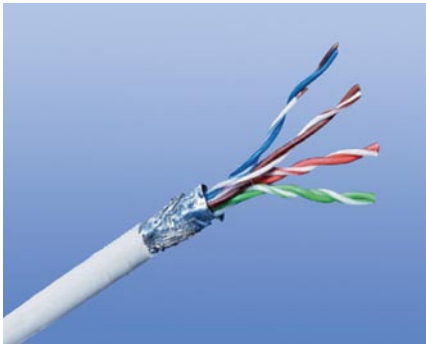

APPLICATION

Cat5E is a cable standard for Gigabit Ethernet and other network protocol, suitable for basic voice and data installations up to 100 MHz. In addition, these cables can be offered with copper wire braid armoured & flame retardant outer sheath, providing additional mechanically protection still maintaining the flexibility of the cable. With special design for the outer jacket, the cables are flexible and are suitable for operation at high temperature, protecting this cables from premature aging, while LSZH properties assure low smoke and corrosive gas in the event of a fire.

STANDARDS

Basic design to EN50173

FIRE PERFORMANCE

Flame Retardance (Single Vertical Wire Test)	EN 60332-1-2; IEC 60332-1-2; BS EN 60332-1-2; VDE 0482-332-1 ; NBN C 30-004 (cat. F1); NF C32-070-2.1(C2); CEI 20-35/1-2; EN 50265-2-1*; DIN VDE 0482-265-2-1*
Reduced Fire Propagation (Vertically-mounted bundled wires & cable test)	EN 60332-3-24 (cat. C); IEC 60332-3-24; BS EN 60332-3-24; VDE 0482-332-3; NBN C 30-004 (cat. F2); NF C32-070-2.2(C1); CEI 20-22/3-4; EN 50266-2-4*; DIN VDE 0482-266-2-4
Halogen Free	IEC 60754-1; EN 50267-2-1; DIN VDE 0482-267-2-1; CEI 20-37/2-1 ; BS 6425-1*
No Corrosive Gas Emission	IEC 60754-2; EN 50267-2-2; DIN VDE 0482-267-2-2; CEI 20-37/2-2 ; BS 6425-2*
Minimum Smoke Emission	IEC 61034-1&2; EN 61034 -1&2; DIN VDE 0482-1034-1&2; CEI 20-37/3-1&2; EN 50268-1&2*; BS 7622-1&2*
No Toxic gases	NES 02-713; NF C 20-454

Note: Asterisk * denotes superseded standard.

VOLTAGE RATING

60V

CABLE CONSTRUCTION

Conductors: 24AWG solid bare copper.

Insulation: HDPE.

Twinning: Two coloured insulated conductors twisted together to form a pair.

Inner Sheath: Flame retardant, low smoke and halogen-free polyolefin, coloured black.

Armouring:

CWB: Copper Wire Braid

SWB: Steel Wire Braid

SWA: Steel Wire Armour

Outer Sheath: Thermoplastic LSZH compound type LTS3 as per BS 7655-6.1 (Thermosetting LSZH compound type SW2-SW4 as per BS 7655:section 2.6 can be offered.)

Cat5E F/UTP: These cables have collective shielding of aluminium/Polyester tape with drain wire.

Cat5E SF/UTP: These cables have double collective shieldings of aluminium/Polyester tape & copper wire braid.

PHYSICAL AND THERMAL PROPERTIES

Temperature range: -30°C ~ +90°C

Minimum bending radius during installation (mobile state): 8 x Overall Diameter

Minimum bending radius during operation (fixed state): 4 x Overall Diameter

ELECTRICAL PROPERTIES

AWG		24
Nominal Conductor Diameter	mm	0.5/0.53
Maximum DC Resistant@20°C	Ω/100m	9.38
Maximum DCR Unbalance	%	5
Maximum Mutual Capacitance	pF/m	55.8
Maximum Capacitance Unbalance	pF/100m	330
Characteristic Impedance@1-100MHz	Ω	100+/-15
Maximum Propagation Delay Skew	ns/100m	45

TRANSMISSION PROPERTIES

FREQ MHz	Maximum Attenuation dB/100m	Minimum NEXT dB	Minimum PSNEXT dB	Minimum ELFEXT dB/100m	Minimum PSELFEXT dB/100m	Minimum RL dB
0.772	1.8	67.0	64.0	66.0	63.0	—
1	2.0	65.3	62.3	63.8	60.8	20.0



FREQ MHz	Maximum Attenuation dB/100m	Minimum NEXT dB	Minimum PSNEXT dB	Minimum ELFEXT dB/100m	Minimum PSELFEXT dB/100m	Minimum RL dB
4	4.1	56.3	53.3	51.7	48.7	23.0
8	5.8	51.8	48.8	45.7	42.7	24.5
10	6.5	50.3	47.3	43.8	40.8	25.0
16	8.2	47.3	44.3	39.7	36.7	25.0
20	9.3	45.8	42.8	37.7	34.7	25.0
25	10.4	44.3	41.3	35.8	32.8	24.3
31.25	11.7	42.9	39.9	33.9	30.9	23.6
62.5	17.0	38.4	35.4	27.8	24.8	21.5
100	22.0	35.3	32.3	23.8	20.8	20.1

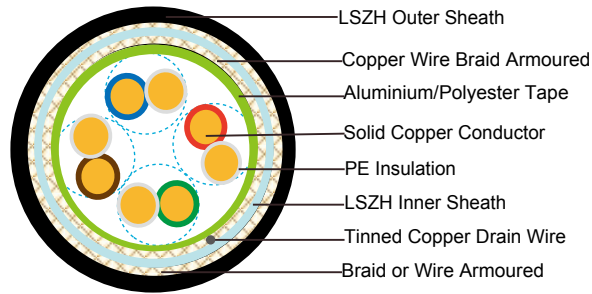
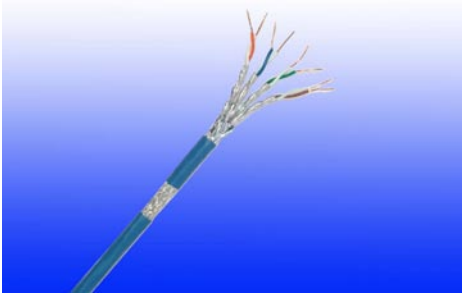

CAT5E SF/UTP

CONSTRUCTION PARAMETERS

Cable Code	Construction No. of elements×No. of cores in element×Conductor diameter	Nominal Insulation Thickness	Nominal Inner Sheath Thickness	Nominal Outer Sheath Thickness	Nominal Overall Diameter	Nominal Weight
	mm	mm	mm	mm	mm	kg/km
CAT5E U/UTP CWB	4×2×0.5	0.2	0.6	1.0	7.68	97
CAT5E U/UTP SWB	4×2×0.5	0.2	0.6	1.0	7.68	93
CAT5E U/UTP SWA	4×2×0.5	0.2	0.6	1.0	8.68	165
CAT5E F/UTP CWB	4×2×0.53	0.2	0.6	1.0	8.28	116

Cable Code	Construction No. of elements×No. of cores in element×Conductor diameter	Nominal Insulation Thickness	Nominal Inner Sheath Thickness	Nominal Outer Sheath Thickness	Nominal Overall Diameter	Nominal Weight
	mm	mm	mm	mm	mm	kg/km
CAT5E F/UTP SWB	4×2×0.53	0.2	0.6	1.0	8.28	112
CAT5E F/UTP SWA	4×2×0.53	0.2	0.6	1.0	9.28	192
CAT5E SF/UTP CWB	4×2×0.53	0.2	0.6	1.0	8.76	123
CAT5E SF/UTP SWB	4×2×0.53	0.2	0.6	1.0	8.76	119
CAT5E SF/UTP SWA	4×2×0.53	0.2	0.6	1.0	9.76	216



Rated Voltage



Standard



Reduced Fire Propagation
NF C32-070-2.2(C1)
IEC60332-3-24/EN50266-2-4



Flame Retardancy
NF C32-070-2.1(C2)
IEC60332-1-2/EN50265-2-1

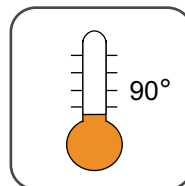

Operating Temperature



Low Toxicity
NES 02-713/NF C 20-454



Low Corrosivity
IEC60754-2
EN50267-2-2/3
NF C 32-074



Low Smoke Emission
IEC 61034-1&2
EN 50268-1&2/NF C32-073



Halogen Free
IEC60754-1
EN50267-2-1



Highly Flexible



Flame Retardant CAT6 Data Cables

FTX-CAT6 U/UTP4P23
FTX-CAT6 F/UTP4P23
FTX-CAT6 SF/FTP4P23

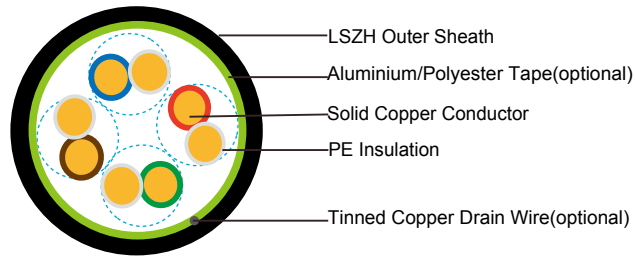
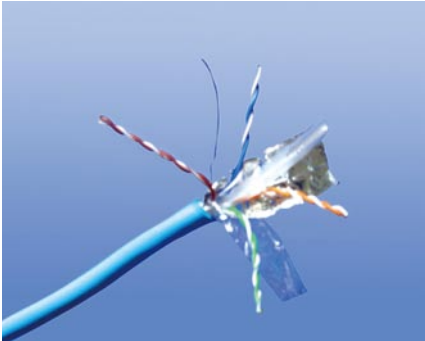

APPLICATION

Cat6 Cable is a cable standard for Gigabit Ethernet and other network protocol, suitable for 10BaseT, 100BaseTx & 1000BaseT (Gigabit Ethernet) application. In addition, these cables can be offered with copper wire braid armoured & flame retardant outer sheath, providing additional mechanically protection still maintaining the flexibility of the cable. With special design for the outer jacket, the cables are flexible and are suitable for operation at high temperature, protecting this cables from premature aging, while LSZH properties assure low smoke and corrosive gas in the event of a fire.

STANDARDS

Basic design to EN50173

FIRE PERFORMANCE

Flame Retardance (Single Vertical Wire Test)	EN 60332-1-2; IEC 60332-1-2; BS EN 60332-1-2; VDE 0482-332-1 ; NBN C 30-004 (cat. F1); NF C32-070-2.1(C2); CEI 20-35/1-2; EN 50265-2-1*; DIN VDE 0482-265-2-1*
Reduced Fire Propagation (Vertically-mounted bundled wires & cable test)	EN 60332-3-24 (cat. C); IEC 60332-3-24; BS EN 60332-3-24; VDE 0482-332-3; NBN C 30-004 (cat. F2); NF C32-070-2.2(C1); CEI 20-22/3-4; EN 50266-2-4*; DIN VDE 0482-266-2-4
Halogen Free	IEC 60754-1; EN 50267-2-1; DIN VDE 0482-267-2-1; CEI 20-37/2-1 ; BS 6425-1*
No Corrosive Gas Emission	IEC 60754-2; EN 50267-2-2; DIN VDE 0482-267-2-2; CEI 20-37/2-2 ; BS 6425-2*
Minimum Smoke Emission	IEC 61034-1&2; EN 61034 -1&2; DIN VDE 0482-1034-1&2; CEI 20-37/3-1&2; EN 50268-1&2*; BS 7622-1&2*
No Toxic gases	NES 02-713; NF C 20-454

Note: Asterisk * denotes superseded standard.

VOLTAGE RATING

60V

CABLE CONSTRUCTION

Conductors: 23AWG solid bare copper.

Insulation: HDPE.

Twinning: Two coloured insulated conductors twisted together to form a pair.

Outer Sheath: Thermoplastic LSZH compound type LTS3 as per BS 7655-6.1 (Thermosetting LSZH compound type SW2-SW4 as per BS 7655:section 2.6 can be offered.)

Cat6 F/UTP: These cables have collective shielding of aluminium/Polyester tape with drain wire.

Cat6 SF/UTP: These cables have double collective shieldings of aluminium/Polyester tape & copper wire braid with drain wire.

PHYSICAL AND THERMAL PROPERTIES

Temperature range: -30°C ~ +90°C

Minimum bending radius during installation (mobile state): 8 x Overall Diameter

Minimum bending radius during operation (fixed state): 4 x Overall Diameter

ELECTRICAL PROPERTIES

AWG		23
Nominal Conductor Diameter	mm	0.56/0.57/0.58
Maximum DC Resistant@20°C	Ω/100m	9.38
Maximum DCR Unbalance	%	3
Maximum Mutual Capacitance	pF/m	5.8
Maximum Capacitance Unbalance	pF/100m	30
Characteristic Impedance@1-100MHz	Ω	100+/-15
Maximum Propagation Delay Skew	ns/100m	18

TRANSMISSION PROPERTIES

FREQ MHz	Maximum Attenuation dB/100m	Minimum NEXT dB	Minimum PSNEXT dB	Minimum ELFEXT dB/100m	Minimum PSELFEXT dB/100m	Minimum RL dB
0.772	1.8	76.0	74.	70.0	67.0	—
1	2.0	74.3	72.3	67.8	64.8	20.0
4	3.8	65.3	63.3	55.7	52.7	23.0
8	5.3	60.8	58.8	49.7	46.7	24.5
10	6.0	59.3	57.3	47.8	44.8	25.0
16	7.6	56.3	54.3	43.7	40.7	25.0



FREQ MHz	Maximum Attenuation dB/100m	Minimum NEXT dB	Minimum PSNEXT dB	Minimum ELFEXT dB/100m	Minimum PSELFEXT dB/100m	Minimum RL dB
20	8.5	54.8	52.8	41.7	38.7	25.0
25	9.5	53.3	51.3	39.8	36.8	24.3
31.25	10.7	51.9	49.9	37.9	34.9	23.6
62.5	15.4	47.4	45.4	31.8	28.8	21.5
100	19.8	44.3	42.3	27.8	24.8	20.1
155	25.2	41.5	39.5	23.9	20.9	18.8
200	29.0	39.8	37.8	21.7	18.7	18.0
250	32.8	38.3	36.3	19.8	16.8	17.3

CONSTRUCTION PARAMETERS

Cable Code	Conductor Diameter	Diameter Over Insulation	Pairs	Screen	Overall Diameter
	mm	mm			mm
Cat6 U/UTP	0.56/0.57	1.02	4	Nil	6.0
Cat6 F/UTP	0.57/0.58	1.02	4	Overall Aluminum Tape Screen	6.3
Cat6 SF/UTP	0.57/0.58	1.02	4	Overall Aluminum Tape Screen & Copper Wire Braid	6.6



60V

Rated Voltage



EN 50173

Standard



Reduced Fire Propagation
NF C32-070-2.2(C1)
IEC60332-3-24/EN50266-2-4



Flame Retardancy
NF C32-070-2.1(C2)
IEC60332-1-2/EN50265-2-1

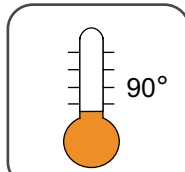

90°

Operating Temperature



Low Toxicity
NES 02-713/NF C 20-454



Low Corrosivity
IEC60754-2
EN50267-2-2/3
NF C 32-074



Low Smoke Emission
IEC 61034-1&2
EN 50268-1&2/NF C32-073

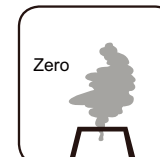

Zero

Halogen Free
IEC60754-1
EN50267-2-1



Highly Flexible

Flame Retardant CAT6 CWB/SWB/SWA Armoured Data Cables

FTX-CAT6 U/UTP4P23 CWB/SWB/SWA
 FTX-CAT6 F/UTP4P23 CWB/SWB/SWA
 FTX-CAT6 SF/UTP4P23 CWB/SWB/SWA

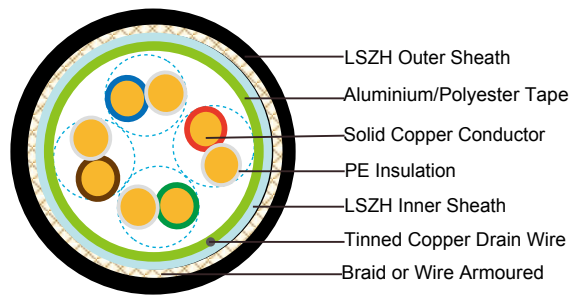
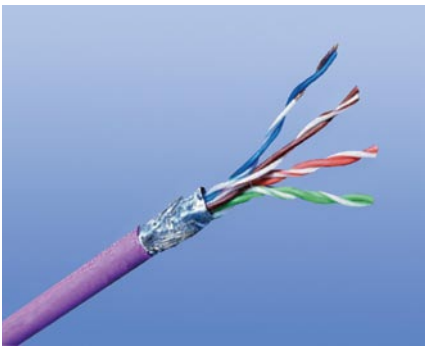

APPLICATION

Cat6 Cable is a cable standard for Gigabit Ethernet and other network protocol, suitable for 10BaseT, 100BaseTx & 1000BaseT (Gigabit Ethernet) application. In addition, these cables can be offered with copper wire braid armoured & flame retardant outer sheath, providing additional mechanically protection still maintaining the flexibility of the cable. With special design for the outer jacket, the cables are flexible and are suitable for operation at high temperature, protecting this cables from premature aging, while LSZH properties assure low smoke and corrosive gas in the event of a fire.

STANDARDS

Basic design to EN50173

FIRE PERFORMANCE

Flame Retardance (Single Vertical Wire Test)	EN 60332-1-2; IEC 60332-1-2; BS EN 60332-1-2; VDE 0482-332-1 ; NBN C 30-004 (cat. F1); NF C32-070-2.1(C2); CEI 20-35/1-2; EN 50265-2-1*; DIN VDE 0482-265-2-1*
Reduced Fire Propagation (Vertically-mounted bundled wires & cable test)	EN 60332-3-24 (cat. C); IEC 60332-3-24; BS EN 60332-3-24; VDE 0482-332-3; NBN C 30-004 (cat. F2); NF C32-070-2.2(C1); CEI 20-22/3-4; EN 50266-2-4*; DIN VDE 0482-266-2-4
Halogen Free	IEC 60754-1; EN 50267-2-1; DIN VDE 0482-267-2-1; CEI 20-37/2-1 ; BS 6425-1*
No Corrosive Gas Emission	IEC 60754-2; EN 50267-2-2; DIN VDE 0482-267-2-2; CEI 20-37/2-2 ; BS 6425-2*
Minimum Smoke Emission	IEC 61034-1&2; EN 61034 -1&2; DIN VDE 0482-1034-1&2; CEI 20-37/3-1&2; EN 50268-1&2*; BS 7622-1&2*
No Toxic gases	NES 02-713; NF C 20-454

Note: Asterisk * denotes superseded standard.



VOLTAGE RATING

60V

CABLE CONSTRUCTION

Conductors: 23AWG solid bare copper.

Insulation: HDPE .

Twinning: Two coloured insulated conductors twisted together to form a pair.

Inner Sheath: Flame retardant, low smoke and halogen-free polyolefin, coloured black.

Armouring:

CWB: Copper Wire Braid

SWB: Steel Wire Braid

SWA: Steel Wire Armour

Outer Sheath: Thermoplastic LSZH compound type LTS3 as per BS 7655-6.1 (Thermosetting LSZH compound type SW2-SW4 as per BS 7655:section 2.6 can be offered.) **Cat6 F/UTP:** These cables have collective shielding of aluminium/Polyester tape with drain wire.

Cat6 SF/UTP: These cables have double collective shieldings of aluminium/Polyester tape & copper wire braid with drain wire.

PHYSICAL AND THERMAL PROPERTIES

Temperature range: -30°C ~ +90°C

Minimum bending radius during installation (mobile state): 8 x Overall Diameter

Minimum bending radius during operation (fixed state): 4 x Overall Diameter

ELECTRICAL PROPERTIES

AWG		23
Nominal Conductor Diameter	mm	0.56/0.57/0.58
Maximum DC Resistant@20°C	Ω/100m	9.38
Maximum DCR Unbalance	%	3
Maximum Mutual Capacitance	pF/m	5.8
Maximum Capacitance Unbalance	pF/100m	30
Characteristic Impedance@1-100MHz	Ω	100+/-15
Maximum Propagation Delay Skew	ns/100m	18

TRANSMISSION PROPERTIES

FREQ MHz	Maximum Attenuation dB/100m	Minimum NEXT dB	Minimum PSNEXT dB	Minimum ELFEXT dB/100m	Minimum PSELFEXT dB/100m	Minimum RL dB
0.772	1.8	76.0	74.	70.0	67.0	—
1	2.0	74.3	72.3	67.8	64.8	20.0
4	3.8	65.3	63.3	55.7	52.7	23.0

FREQ MHz	Maximum Attenuation dB/100m	Minimum NEXT dB	Minimum PSNEXT dB	Minimum ELFEXT dB/100m	Minimum PSELFEXT dB/100m	Minimum RL dB
8	5.3	60.8	58.8	49.7	46.7	24.5
10	6.0	59.3	57.3	47.8	44.8	25.0
16	7.6	56.3	54.3	43.7	40.7	25.0
20	8.5	54.8	52.8	41.7	38.7	25.0
25	9.5	53.3	51.3	39.8	36.8	24.3
31.25	10.7	51.9	49.9	37.9	34.9	23.6
62.5	15.4	47.4	45.4	31.8	28.8	21.5
100	19.8	44.3	42.3	27.8	24.8	20.1
155	25.2	41.5	39.5	23.9	20.9	18.8
200	29.0	39.8	37.8	21.7	18.7	18.0
250	32.8	38.3	36.3	19.8	16.8	17.3

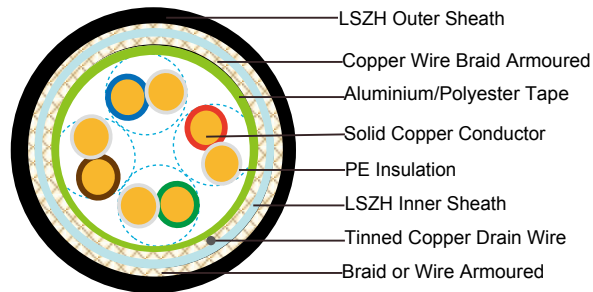

CAT6 SF/UTP

CONSTRUCTION PARAMETERS

Cable Code	Construction No. of elements×No. of cores in element×Conductor diameter	Nominal Insulation Thickness	Nominal Inner Sheath Thickness	Nominal Outer Sheath Thickness	Nominal Overall Diameter	Nominal Weight
	mm	mm	mm	mm	mm	kg/km
CAT6 U/UTP CWB	4×2×0.56/0.57	0.2	0.6	1.0	7.88	115
CAT6 U/UTP SWB	4×2×0.56/0.57	0.2	0.6	1.0	7.88	109
CAT6 U/UTP SWA	4×2×0.56/0.57	0.2	0.6	1.0	8.88	189



Caledonian

Flame Retardant Data Cables

www.caledonian-cables.co.uk www.addison-cables.com



Cable Code	Construction No. of elements×No. of cores in element×Conductor diameter	Nominal Insulation Thickness	Nominal Inner Sheath Thickness	Nominal Outer Sheath Thickness	Nominal Overall Diameter	Nominal Weight
	mm	mm	mm	mm	mm	kg/km
CAT6 F/UTP CWB	4×2×0.57/0.58	0.2	0.6	1.0	8.48	126
CAT6 F/UTP SWB	4×2×0.57/0.58	0.2	0.6	1.0	8.48	132
CAT6 F/UTP SWA	4×2×0.57/0.58	0.2	0.6	1.0	9.48	213
CAT6 SF/UTP CWB	4×2×0.57/0.58	0.2	0.6	1.0	8.96	154
CAT6 SF/UTP SWB	4×2×0.57/0.58	0.2	0.6	1.0	8.96	148
CAT6 SF/UTP SWA	4×2×0.57/0.58	0.2	0.6	1.0	9.96	242



60V

Rated Voltage



EN 50173

Standard



Reduced Fire Propagation
NF C32-070-2.2(C1)
IEC60332-3-24/EN50266-2-4



Flame Retardancy
NF C32-070-2.1(C2)
IEC60332-1-2/EN50265-2-1

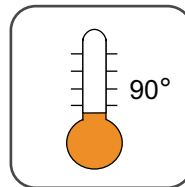

90°

Operating Temperature



Low Toxicity
NES 02-713/NF C 20-454



Low Corrosivity
IEC60754-2
EN50267-2-2/3
NF C 32-074



Low Smoke Emission
IEC 61034-1&2
EN 50268-1&2/NF C32-073

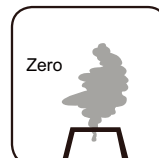

Zero

Halogen Free
IEC60754-1
EN50267-2-1



Highly Flexible

Flame Retardant RS485 Databus Cables

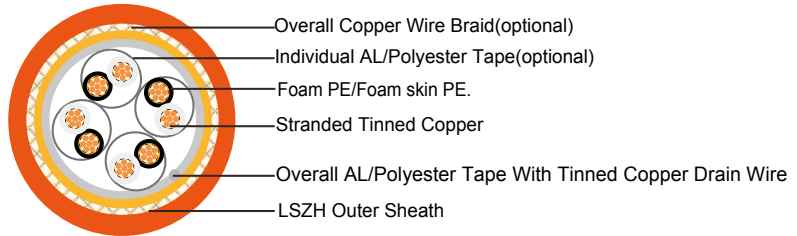
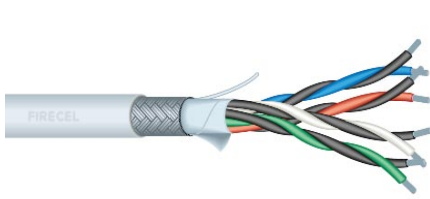

APPLICATION

The cables are designed for RS485 data connections where continued functionality is required during a fire situation. This cable combines low capacitance insulation with one of the highest levels of screening to provide high speed, interference free, data transmission where continued functionality is required during a fire situation. With special design for the outer jacket, the cables are flexible and are suitable for operation at high temperature, protecting this cables from premature aging, while LSZH properties assure low smoke and corrosive gas in the event of a fire.

STANDARDS

Basic design to EIA/TIA 485

FIRE PERFORMANCE

Flame Retardance (Single Vertical Wire Test)	EN 60332-1-2; IEC 60332-1-2; BS EN 60332-1-2; VDE 0482-332-1 ; NBN C 30-004 (cat. F1); NF C32-070-2.1(C2); CEI 20-35/1-2; EN 50265-2-1*; DIN VDE 0482-265-2-1*
Reduced Fire Propagation (Vertically-mounted bundled wires & cable test)	EN 60332-3-24 (cat. C); IEC 60332-3-24; BS EN 60332-3-24; VDE 0482-332-3; NBN C 30-004 (cat. F2); NF C32-070-2.2(C1); CEI 20-22/3-4; EN 50266-2-4*; DIN VDE 0482-266-2-4
Halogen Free	IEC 60754-1; EN 50267-2-1; DIN VDE 0482-267-2-1; CEI 20-37/2-1 ; BS 6425-1*
No Corrosive Gas Emission	IEC 60754-2; EN 50267-2-2; DIN VDE 0482-267-2-2; CEI 20-37/2-2 ; BS 6425-2*
Minimum Smoke Emission	IEC 61034-1&2; EN 61034 -1&2; DIN VDE 0482-1034-1&2; CEI 20-37/3-1&2; EN 50268-1&2*; BS 7622-1&2*
No Toxic gases	NES 02-713; NF C 20-454

Note: Asterisk * denotes superseded standard..

CABLE CONSTRUCTION

Multipair RS 485 Overall Screened Databus Cable

Conductors: Tinned copper wire, stranded according to IEC(EN) 60228 class 2.

Insulation: Foam PE or foam skin PE.

Cabling Elements: Insulated cores are twisted to form pairs with varying lay length to minimize crosstalk. Two pair cable had four cores laid in quad formation.

Cabling: Pairs are cabled together in concentric layers.



Overall Screen: Aluminum/polyester tape with tinned copper drain wire.

Outer Sheath: Thermoplastic LSZH compound type LTS3 as per BS 7655-6.1 (Thermosetting LSZH compound type SW2-SW4 as per BS 7655-2.6 can be offered.)

Multipair RS 485 Overall Double Screened Databus Cable

Conductors: Tinned copper wire, stranded according to IEC(EN) 60228 class 2.

Insulation: Foam PE or foam skin PE.

Cabling Elements: Insulated cores are twisted to form pairs with varying lay length to minimize crosstalk. Two pair cable had four cores laid in quad formation.

Cabling: Pairs are cabled together in concentric layers.

Overall Screen: Aluminium/polyester tape+copper wire braid.

Outer Sheath: Thermoplastic LSZH compound type LTS3 as per BS 7655-6.1 (Thermosetting LSZH compound type SW2-SW4 as per BS 7655-2.6 can be offered.)

Multipair RS 485 Individual & Overall Screened Databus Cable

Conductors: Tinned copper wire, stranded according to IEC(EN) 60228 class 2.

Insulation: Foam PE or foam skin PE.

Cabling Elements: Insulated cores are twisted to form pairs with varying lay length to minimize crosstalk. Two pair cable had four cores laid in quad formation.

Cabling: Pairs are cabled together in concentric layers.

Individual Screen: Individual aluminium/polyester tape.

Overall Screen: Copper wire braid.

outer Sheath: Thermoplastic LSZH compound type LTS3 as per BS 7655-6.1 (Thermosetting LSZH compound type SW2-SW4 as per BS 7655-2.6 can be offered.)

Multipair RS 485 Overall Screened Databus Cable

Conductors: Tinned copper wire, stranded according to IEC(EN) 60228 class 2.

Insulation: Foam PE or foam skin PE.

Cabling Elements: Insulated cores are twisted to form pairs with varying lay length to minimize crosstalk. Two pair cable had four cores laid in quad formation.

Cabling: Pairs are cabled together in concentric layers.

Overall Screen: Copper wire braid.

Outer Sheath: Thermoplastic LSZH compound type LTS3 as per BS 7655-6.1 (Thermosetting LSZH compound type SW2-SW4 as per BS 7655-2.6 can be offered.)

PHYSICAL AND THERMAL PROPERTIES

Temperature range during operation (fixed state): -30°C - +90°C

Temperature range during installation (mobile state): -5°C - +60°C

Minimum bending radius: 8 x Overall Diameter

ELECTRICAL PROPERTIES

Dielectric test	1000 V r.m.s. for 5' (core-core)
	1000 V r.m.s. for 5' (core-screen)
Impedance	120Ω
Capacitance	45 nF/km conductor to conductor
	90 nF/km conductor to shield

CONSTRUCTION PARAMETERS

Multipair RS 485 Overall Screened Databus Cable

RE-02Y(St)H / RE-02YS(St)H

No. of pair x	Nominal Cross Sectional Area	No./Nominal Diameter of Strands	Nominal Insulation Thickness	Nominal Sheath Thickness	Nominal Overall Diameter	Approx. Weight
	mm ²	No/mm	mm	mm	mm	kg/km
1	0.22	7/0.2	0.55	0.40	4.0	21
2	0.22	7/0.2	0.55	0.40	7.1	42
4	0.22	7/0.2	0.55	0.40	8.3	68
1	0.50	16/0.2	0.55	0.40	4.6	32
2	0.50	16/0.2	0.55	0.40	8.2	68
4	0.50	16/0.2	0.55	0.40	9.8	115
1	0.75	24/0.2	0.55	0.40	5.1	40
2	0.75	24/0.2	0.55	0.40	9.1	84
4	0.75	24/0.2	0.55	0.40	10.9	144
1	1.00	30/0.2	0.55	0.40	5.2	49
2	1.00	30/0.2	0.55	0.40	9.5	105
4	1.00	30/0.2	0.55	0.40	11.2	182

Multipair RS 485 Overall Double Screened Databus Cable

RE-02Y(St)CH / RE-02YS(St)CH

No. of pair x	Nominal Cross Sectional Area	No./Nominal Diameter of Strands	Nominal Insulation Thickness	Nominal Sheath Thickness	Nominal Overall Diameter	Approx. Weight
	mm ²	No/mm	mm	mm	mm	kg/km
1	0.22	7/0.2	0.55	0.40	4.5	34
2	0.22	7/0.2	0.55	0.40	7.5	67
4	0.22	7/0.2	0.55	0.40	8.8	97
1	0.50	16/0.2	0.55	0.40	5.1	48
2	0.50	16/0.2	0.55	0.40	8.7	97
4	0.50	16/0.2	0.55	0.40	10.3	150
1	0.75	24/0.2	0.55	0.40	5.6	57
2	0.75	24/0.2	0.55	0.40	9.7	116
4	0.75	24/0.2	0.55	0.40	11.4	182
1	1.00	30/0.2	0.55	0.40	5.7	67
2	1.00	30/0.2	0.55	0.40	10.0	138
4	1.00	30/0.2	0.55	0.40	11.8	222



Multipair RS 485 Individual & Overall Screened Databus Cable

RE-02Y(St)H PiMF / RE-02YS(St)H PiMF

No. of pair x	Nominal Cross Sectional Area	No./Nominal Diameter of Strands	Nominal Insulation Thickness	Nominal Sheath Thickness	Nominal Overall Diameter	Approx. Weight
	mm ²	No/mm	mm	mm	mm	kg/km
1	0.22	7/0.2	0.55	0.40	4.4	35
2	0.22	7/0.2	0.55	0.40	7.5	69
4	0.22	7/0.2	0.55	0.40	8.8	106
1	0.50	16/0.2	0.55	0.40	5.0	49
2	0.50	16/0.2	0.55	0.40	8.7	100
4	0.50	16/0.2	0.55	0.40	10.3	159
1	0.75	24/0.2	0.55	0.40	5.5	58
2	0.75	24/0.2	0.55	0.40	9.7	119
4	0.75	24/0.2	0.55	0.40	11.2	174
1	1.00	30/0.2	0.55	0.40	5.6	68
2	1.00	30/0.2	0.55	0.40	10.0	142
4	1.00	30/0.2	0.55	0.40	11.8	234

Multipair RS 485 Overall Screened Databus Cable

RE-02YCH / RE-02YSCH

No. of pair x	Nominal Cross Sectional Area	No./Nominal Diameter of Strands	Nominal Insulation Thickness	Nominal Sheath Thickness	Nominal Overall Diameter	Approx. Weight
	mm ²	No/mm	mm	mm	mm	kg/km
1	0.22	7/0.2	0.55	0.40	4.3	31
2	0.22	7/0.2	0.55	0.40	7.3	61
4	0.22	7/0.2	0.55	0.40	8.5	91
1	0.50	16/0.2	0.55	0.40	4.9	44
2	0.50	16/0.2	0.55	0.40	8.5	91
4	0.50	16/0.2	0.55	0.40	10.0	142
1	0.75	24/0.2	0.55	0.40	5.4	53
2	0.75	24/0.2	0.55	0.40	9.5	109
4	0.75	24/0.2	0.55	0.40	11.2	174
1	1.00	30/0.2	0.55	0.40	5.5	63
2	1.00	30/0.2	0.55	0.40	9.8	131
4	1.00	30/0.2	0.55	0.40	11.5	213

TYPE CODES

RE-A-B-D

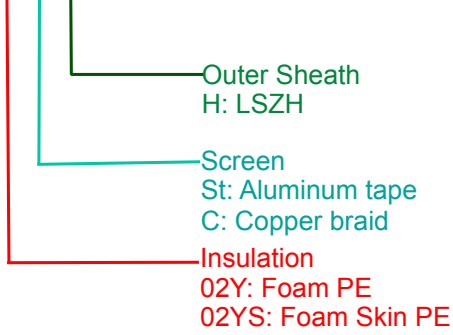

Rated Voltage



Standard



Reduced Fire Propagation
NF C32-070-2.2(C1)
IEC60332-3-24/EN50266-2-4



Flame Retardancy
NF C32-070-2.1(C2)
IEC60332-1-2/EN50265-2-1

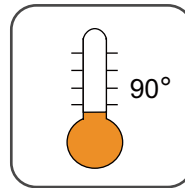

Operating Temperature



Low Toxicity
NES 02-713/NF C 20-454



Low Corrosivity
IEC60754-2
EN50267-2-2/3
NF C 32-074



Low Smoke Emission
IEC 61034-1&2
EN 50268-1&2/NF C32-073

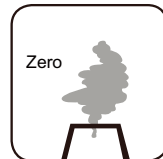

Halogen Free
IEC60754-1
EN50267-2-1

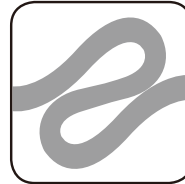

Highly Flexible



Flame Retardant Profibus DP IEC 61158 / EN 50170 SINEC L2(Siemens Profibus)

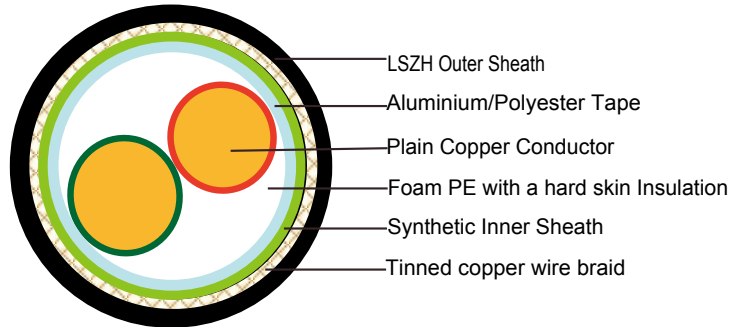

APPLICATION:

Profibus DP cables are designed for field networks requiring fast, cyclic data exchange between controllers and field devices. This cable is usually referred as siemens profibus. This Profibus modification optimized with respect to velocity and low installation cost, Profibus DP is used as a replacement for conventional parallel data transmission with 24 V or 0 - 20 mA. With special design for the outer jacket, the cables are flexible and are suitable for operation at high temperature, protecting this cables from premature aging, while LSZH properties assure low smoke and corrosive gas in the event of a fire.

FIRE PERFORMANCE

Flame Retardance (Single Vertical Wire Test)	EN 60332-1-2; IEC 60332-1-2; BS EN 60332-1-2; VDE 0482-332-1 ; NBN C 30-004 (cat. F1); NF C32-070-2.1(C2); CEI 20-35/1-2; EN 50265-2-1*; DIN VDE 0482-265-2-1*
Reduced Fire Propagation (Vertically-mounted bundled wires & cable test)	EN 60332-3-24 (cat. C); IEC 60332-3-24; BS EN 60332-3-24; VDE 0482-332-3; NBN C 30-004 (cat. F2); NF C32-070-2.2(C1); CEI 20-22/3-4; EN 50266-2-4*; DIN VDE 0482-266-2-4
Halogen Free	IEC 60754-1; EN 50267-2-1; DIN VDE 0482-267-2-1; CEI 20-37/2-1 ; BS 6425-1*
No Corrosive Gas Emission	IEC 60754-2; EN 50267-2-2; DIN VDE 0482-267-2-2; CEI 20-37/2-2 ; BS 6425-2*
Minimum Smoke Emission	IEC 61034-1&2; EN 61034 -1&2; DIN VDE 0482-1034-1&2; CEI 20-37/3-1&2; EN 50268-1&2*; BS 7622-1&2*
No Toxic gases	NES 02-713; NF C 20-454

Note: Asterisk * denotes superseded standard.

**STATIC CABLES
CONSTRUCTION:**

Type	Static cables
Inner Conductor	Plain copper
Inner Conductor Diameter	0.64mm (22AWG)
Conductor Insulation	Foam with a hard skin
Conductor Colors	Red & green
Stranding Element	-
Shielding 1	Synthetic bedding
Shielding 2	Aluminium foil
Shielding 3	Tinned copper wire braid – 60% optical coverage
Outer Jacket Material	Thermoplastic LSZH compound
Outer Jacket Color	Violet/ Black

ELECTRICAL DATA:

Characteristic Impedance @ 3-20MHz	150 Ω ± 10 Ω	
Conductor Resistance	57.1 Ohm/km max.	
Test Voltage	1.5KV	
Operate Voltage	Max: 350V	
Effective capacitance @ 1khz	28.5nF/m	
Data Rate	9.6 Kbit/s	1200m
	19.2 Kbit/s	1200m
	93.75 Kbit/s	1200m
	187.5 Kbit/s	1000m
	500 Kbit/s	400m
	1.5 Mbit/s	200m
	12.0 Mbit/s	100m
Attenuation:	4MHz	22dB/100m
	9.6MHz	2.5dB/100m
	16MHz	42dB/100m



DYNAMIC CABLES CONSTRUCTION:

Type	Dynamic cables
Inner Conductor:	Plain copper, 0.25mm ²
Conductor Insulation	Foamed PE with a hard skin
Conductor Colors	Red & green
Stranding Element	Cores laid up with fillers
Core Wrapping	Polyester taped
Shielding 1	Aluminium foil
Shielding 2	Tinned copper wire braid – 60% optical coverage
Drain Wire	-
Outer Jacket Material	Polyurethane (PUR) sheath
Outer Jacket Color	Violet/ Black

ELECTRICAL DATA:

Characteristic Impedance @ 3-20MHz	150 Ω ± 10 Ω	
Conductor Resistance	84.0 Ohm/km max.	
Test Voltage	1.5KV	
Working Voltage	Max: 350V	
Effective capacitance @ 1khz	28.5nF/m	
Data Rate	9.6 Kbit/s	1200m
	19.2 Kbit/s	1200m
	93.75 Kbit/s	1200m
	187.5 Kbit/s	1000m
	500 Kbit/s	400m
	1.5 Mbit/s	200m
	12.0 Mbit/s	100m
Attenuation	4MHz	25dB/100m
	9.6MHz	3dB/100m
	16MHz	53dB/100m

PHYSICAL AND THERMAL PROPERTIES

Temperature Range During Operation (Fixed State): -30°C - +70°C

Temperature Range During Installation (Mobile State): -5°C - +60°C

Minimum Bending Radius: 8 X Overall Diameter

TECHNICAL DATA:

	Static	Dynamic
Min. Bending Radius (Laying)	12 x OD mm	12 x OD mm
Operating Temp.Range, min.	-30 °C	-30 °C
Operating Temp.Range, max.	+90 °C	+90 °C



Reduced Fire Propagation
NF C32-070-2.2(C1)
IEC60332-3-24/EN50266-2-1



Flame Retardancy
NF C32-070-2.1(C2)
IEC60332-1-2/EN50265-2-1



Low Smoke Emission
IEC 61034-1&2
EN 50268-1&2/NF C32-073

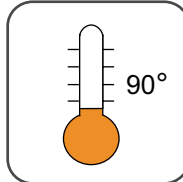

Operating Temperature



Low Toxicity
NES 02-713/NF C 20-454



Low Corrosivity
IEC60754-2
EN50267-2-2/3
NF C 32-074

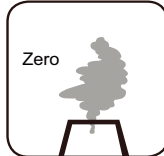

Halogen Free
IEC60754-1
EN50267-2-1



Highly Flexible



Flame Retardant Profibus L2

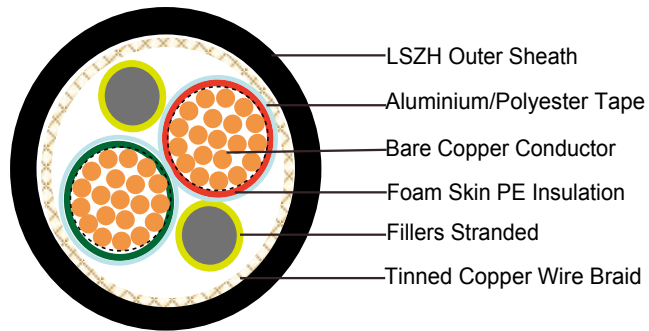

APPLICATION

This system cable is used to interconnect L2-BUS components. This cable is an economical solution for the cell and field area. For the information exchange between different automation systems as well as for communication with the connected decentralized field units, serial fieldbus systems are used. The types mentioned here are suitable for indoor laying, outdoor laying and industry laying underground installation, laying in regular mobile applications, drag chains (stranded). and are equipped with a special LSZH jacket. With special design for the outer jacket, the cables are flexible and are suitable for operation at high temperature, protecting this cables from premature aging, while LSZH properties assure low smoke and corrosive gas in the event of a fire.

FIRE PERFORMANCE

Flame Retardance (Single Vertical Wire Test)	EN 60332-1-2; IEC 60332-1-2; BS EN 60332-1-2; VDE 0482-332-1 ; NBN C 30-004 (cat. F1); NF C32-070-2.1(C2); CEI 20-35/1-2; EN 50265-2-1*; DIN VDE 0482-265-2-1*
Reduced Fire Propagation (Vertically-mounted bundled wires & cable test)	EN 60332-3-24 (cat. C); IEC 60332-3-24; BS EN 60332-3-24; VDE 0482-332-3; NBN C 30-004 (cat. F2); NF C32-070-2.2(C1); CEI 20-22/3-4; EN 50266-2-4*; DIN VDE 0482-266-2-4
Halogen Free	IEC 60754-1; EN 50267-2-1; DIN VDE 0482-267-2-1; CEI 20-37/2-1 ; BS 6425-1*
No Corrosive Gas Emission	IEC 60754-2; EN 50267-2-2; DIN VDE 0482-267-2-2; CEI 20-37/2-2 ; BS 6425-2*
Minimum Smoke Emission	IEC 61034-1&2; EN 61034 -1&2; DIN VDE 0482-1034-1&2; CEI 20-37/3-1&2; EN 50268-1&2*; BS 7622-1&2*
No Toxic gases	NES 02-713; NF C 20-454

Note: Asterisk * denotes superseded standard.

CABLE CONSTRUCTION

Type	Profibus L2 Drag Chain	Profibus ET200X
Cable Construction	1x2x0.64 mm(stranded)	1x2x0.65 mm +3x1x0.75 mm2 (stranded)

Inner Conductor Diameter 1	Copper, bare (AWG 24/19)	Copper, bare (AWG 22/19)
Inner Conductor Diameter 2	-	Copper, bare (AWG 18/24)
Conductor Insulation 1	Foam-Skin-PE	Foam-Skin-PE
Conductor Insulation 2	-	PVC
Conductor Colors 1	Red, green	Red, green
Stranding Element	2 conductors + 2 fillers stranded together	Double Conductor
Shielding	Polyester foil, aluminum-lined	Foil
Wrapping	-	Polyester foil, aluminum lined
Overall wrapping	-	Polyester foil
Total Shielding	Cu braid, tinned	Cu braid
Outer Jacket Material	Thermoplastic LSZH compound	Thermoplastic LSZH compound
Outer Diameter	7.8 ± 0.4 mm /8.0+0.4	9.5 mm ± 0.5 mm
Outer Jacket Color	Violet	Green

ELECTRICAL DATA

Type	Profibus L2 Drag Chain	Profibus ET200X
Characteristic Impedance@3-20Hz	150 Ω ± 10 Ω	150 Ω ± 10 Ω
Conductor Resistance	82hm/km max.	84hm/km max.
Insulation Resistance	1.00 GOhm x km min.	1.00 GOhm x km min.
Mutual Capacitance@1KHz	30.0 nF/km nom.	30.0 nF/km nom.
Working Voltage	Max: 250 V	Max: 250 V
Test Voltage	1.5 KV	1.5 KV
Attenuation	9.6kHz < 2.5dB/km	9.6kHz < 2.5dB/km
	38.4kHz < 4.0dB/km	38.4kHz < 4.0dB/km
	4.0MHz < 22.0dB/km	4.0MHz < 22.0dB/km
	16.0MHz < 45.0dB/km	16.0MHz < 45.0dB/km

TECHNICAL DATA:

Type	Profibus L2 Drag Chain	Profibus ET200X
Weight	approximately 65.0 kg/km	approximately 105 kg/km
Min. Bending Radius for Laying	7.5x OD mm	14x OD mm
Operating Temperature Range, min.	-30 °C	-30 °C
Operating Temperature Range, max.	+90 °C	+90 °C



Reduced Fire Propagation
NF C32-070-2.2(C1)
IEC60332-3-24/EN50266-2-1



Flame Retardancy
NF C32-070-2.1(C2)
IEC60332-1-2/EN50265-2-1



Low Smoke Emission
IEC 61034-1&2
EN 50268-1&2/NF C32-073

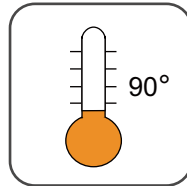

Operating Temperature



Low Toxicity
NES 02-713/NF C 20-454



Low Corrosivity
IEC60754-2
EN50267-2-2/3
NF C 32-074

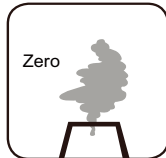

Halogen Free
IEC60754-1
EN50267-2-1



Highly Flexible



Flame Retardant Profibus PA

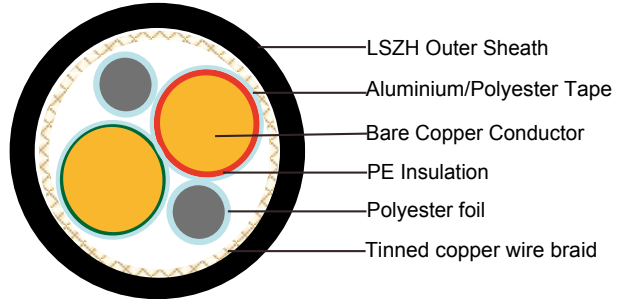

:APPLICATION

This Profibus PA line is used in the area of process automation, among other things in the chemical industry. This cable is an economical solution for the cell and field area. For the information exchange between different automation systems as well as for communication with the connected decentralized field units, serial field bus systems are used. The types mentioned here are suitable for ex and not-ex installation and are equipped with a special LSZH jacket. With special design for the outer jacket, the cables are flexible and are suitable for operation at high temperature, protecting this cables from premature aging, while LSZH properties assure low smoke and corrosive gas in the event of a fire.

FIRE PERFORMANCE

Flame Retardance (Single Vertical Wire Test)	EN 60332-1-2; IEC 60332-1-2; BS EN 60332-1-2; VDE 0482-332-1 ; NBN C 30-004 (cat. F1); NF C32-070-2.1(C2); CEI 20-35/1-2; EN 50265-2-1*; DIN VDE 0482-265-2-1*
Reduced Fire Propagation (Vertically-mounted bundled wires & cable test)	EN 60332-3-24 (cat. C); IEC 60332-3-24; BS EN 60332-3-24; VDE 0482-332-3; NBN C 30-004 (cat. F2); NF C32-070-2.2(C1); CEI 20-22/3-4; EN 50266-2-4*; DIN VDE 0482-266-2-4
Halogen Free	IEC 60754-1; EN 50267-2-1; DIN VDE 0482-267-2-1; CEI 20-37/2-1 ; BS 6425-1*
No Corrosive Gas Emission	IEC 60754-2; EN 50267-2-2; DIN VDE 0482-267-2-2; CEI 20-37/2-2 ; BS 6425-2*
Minimum Smoke Emission	IEC 61034-1&2; EN 61034 -1&2; DIN VDE 0482-1034-1&2; CEI 20-37/3-1&2; EN 50268-1&2*; BS 7622-1&2*
No Toxic gases	NES 02-713; NF C 20-454

Note: Asterisk * denotes superseded standard.

CABLE CONSTRUCTION

Type/Area of Application	Hazardous Areas /Non-Hazardous Areas
Cable Construction	1x2x1.6/3.2 mm
Inner Conductor	Copper, bare (AWG 16/7)
Conductor Insulation	PE
Conductor Colors	red, green
Stranding Element	2 conductors + 2 fillers stranded together
Shielding 1	Polyester foil over stranded bundle
Shielding 2	Polyester foil, aluminum-lined
Total Shielding	Copper braid, tinned
Outer Jacket Material	Thermoplastic LSZH compound
Outer Diameter	9.5 mm ± 0.5 mm
Sheath Colour	Blue

ELECTRICAL DATA:

Characteristic Impedance@31.25Hz	100 Ω±20 Ω	
Conductor resistance	24.0 Ohm/km max.	
Insulation Resistance	1.00 GOhm x km min.	
Mutual Capacitance@1KHz	60.0 nF/km nom.	
Working Voltage	300V	
Test Voltage	1.0KV	
Nominal attenuation	39 MHz	<2.7dB/km

TECHNICAL DATA:

Weight:	76.0 kg/km
Min. Bending Radius (Laying)	18 x OD mm
Operating Temp.Range, min.	-30 °C
Operating Temp.Range, max.	+90 °C



Reduced Fire Propagation
NF C32-070-2.2(C1)
IEC60332-3-24/EN50266-2-4



Flame Retardancy
NF C32-070-2.1(C2)
IEC60332-1-2/EN50265-2-1



Low Smoke Emission
IEC 61034-1&2
EN 50268-1&2/NF C32-073

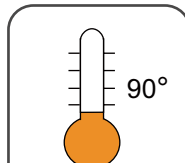

Operating Temperature



Low Toxicity
NES 02-713/NF C 20-454



Low Corrosivity
IEC60754-2
EN50267-2-2/3
NF C 32-074

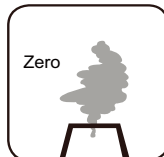

Halogen Free
IEC60754-1
EN50267-2-1



Highly Flexible



Flame Retardant Foundation Fieldbus ISA/SP-50 Bus Cables

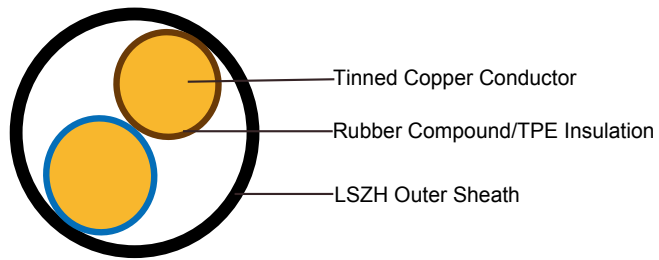

APPLICATION

Foundation™ Field bus is used in intrinsically area, especially in the field of Process Automation. A high speed single pair 22AWG Bi-Directional digital Fieldbus cable. Anti-termite and anti-vermin foundation fieldbus cable is also available. With special design for the outer jacket, the cables are flexible and are suitable for operation at high temperature, protecting this cables from premature aging, while LSZH properties assure low smoke and corrosive gas in the event of a fire.

FIRE PERFORMANCE

Flame Retardance (Single Vertical Wire Test)	EN 60332-1-2; IEC 60332-1-2; BS EN 60332-1-2; VDE 0482-332-1 ; NBN C 30-004 (cat. F1); NF C32-070-2.1(C2); CEI 20-35/1-2; EN 50265-2-1*; DIN VDE 0482-265-2-1*
Reduced Fire Propagation (Vertically-mounted bundled wires & cable test)	EN 60332-3-24 (cat. C); IEC 60332-3-24; BS EN 60332-3-24; VDE 0482-332-3; NBN C 30-004 (cat. F2); NF C32-070-2.2(C1); CEI 20-22/3-4; EN 50266-2-4*; DIN VDE 0482-266-2-4
Halogen Free	IEC 60754-1; EN 50267-2-1; DIN VDE 0482-267-2-1; CEI 20-37/2-1 ; BS 6425-1*
No Corrosive Gas Emission	IEC 60754-2; EN 50267-2-2; DIN VDE 0482-267-2-2; CEI 20-37/2-2 ; BS 6425-2*
Minimum Smoke Emission	IEC 61034-1&2; EN 61034 -1&2; DIN VDE 0482-1034-1&2; CEI 20-37/3-1&2; EN 50268-1&2*; BS 7622-1&2*
No Toxic gases	NES 02-713; NF C 20-454

Note: Asterisk * denotes superseded standard.

CABLE CONSTRUCTION

Type	Type A	Type B	High Speed
Inner Conductor	Tinned copper conductors 18(7)AWG 0.88mm ²	Tinned copper conductors 22AWG 0.34mm ²	Tinned copper conductors 22(7)AWG 0.34mm ²
Conductor Insulation	Polyolefin/Foamed PE with skin PE	Polyolefin/Foamed PE with skin PE	Polyolefin/Foamed PE with skin PE
Stranding Element	-	-	-

Shielding	Aluminium /polyester foil	Aluminium /polyester foil	Aluminium /polyester foil
Drain Wire	(22AWG) tinned copper (20AWG) tinned copper	(22AWG) tinned copper (20AWG) tinned copper	(22AWG) tinned copper (20AWG) tinned copper
Outer Jacket Material	Thermoplastic LSZH compound	Thermoplastic LSZH compound	Thermoplastic LSZH compound
Core Identification	White & Black	White & Black	White & Black
Sheath Colour	Orange	Orange	Orange

ELECTRICAL DATA:

Type	Type A	Type B	High Speed
Characteristic Impedance@31.25Hz	100 Ω±20 Ω	130 Ω±20 Ω	150 Ω±10 Ω
Conductor resistance	24 Ohm/km @ 20°C	56.0Ohm/km @ 20°C	56.0 Ohm/km @ 20°C
Working Voltage	300V	300V	300V
Test Voltage	1.5KV	1.5KV	1.5KV
Attenuation	39 MHz <3 dB/100m	39 MHz <3 dB/100m	39 MHz <3 dB/100m

TECHNICAL DATA

Type	Type A	Type B	High Speed
Weight	approximately 85 kg/km/ 246 kg/km(SWA)	approximately 53 kg/km/ 213 kg/km(SWA)	approximately 65 kg/km/ 287 kg/km(SWA)
Min. Bending Radius (Laying)	15 x OD mm	15 x OD mm	15 x OD mm
Operating Temp.Range, min.	- 30 °C	- 30 °C	- 30 °C
Operating Temp.Range, max.	+90 °C	+90 °C	+90 °C



Reduced Fire Propagation
NF C32-070-2.2(C1)
IEC60332-3-24/EN50266-2-1



Flame Retardancy
NF C32-070-2.1(C2)
IEC60332-1-2/EN50265-2-1



Low Smoke Emission
IEC 61034-1&2
EN 50268-1&2/NF C32-073

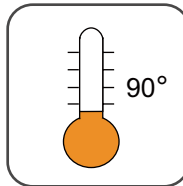

Operating Temperature



Low Toxicity
NES 02-713/NF C 20-454



Low Corrosivity
IEC60754-2
EN50267-2-2/3
NF C 32-074

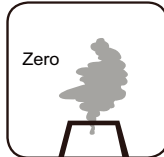

Halogen Free
IEC60754-1
EN50267-2-1



Highly Flexible



Flame Retardant ASI Bus Cables

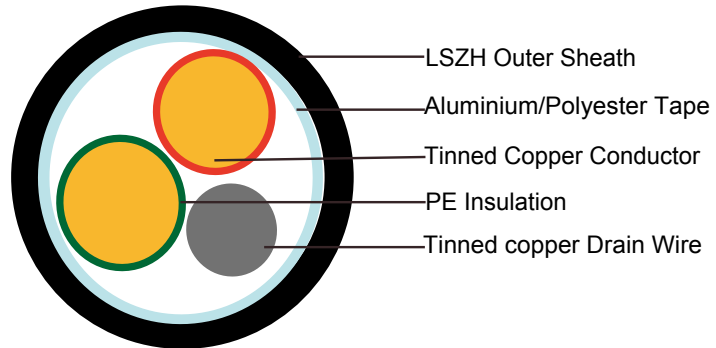
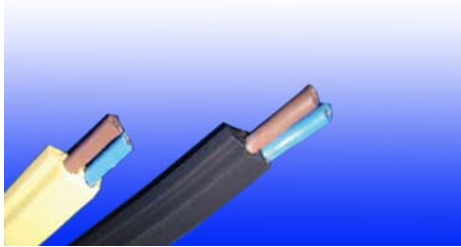

APPLICATION

ASI is standardized Europe-wide in EN 50295 and internationally in IEC 62026-2. Network system for the lowest field level (binary sensors and actuators). Data and energy are transmitted between control unit and peripherals via an unscreened, geometrically coded two-core flat cable (pole safe). The conductor is contacted by piercing technology within the ASI-modules. With special design for the outer jacket, the cables are flexible and are suitable for operation at high temperature, protecting this cables from premature aging, while LSZH properties assure low smoke and corrosive gas in the event of a fire.

FIRE PERFORMANCE

Flame Retardance (Single Vertical Wire Test)	EN 60332-1-2; IEC 60332-1-2; BS EN 60332-1-2; VDE 0482-332-1 ; NBN C 30-004 (cat. F1); NF C32-070-2.1(C2); CEI 20-35/1-2; EN 50265-2-1*; DIN VDE 0482-265-2-1*
Reduced Fire Propagation (Vertically-mounted bundled wires & cable test)	EN 60332-3-24 (cat. C); IEC 60332-3-24; BS EN 60332-3-24; VDE 0482-332-3; NBN C 30-004 (cat. F2); NF C32-070-2.2(C1); CEI 20-22/3-4; EN 50266-2-4*; DIN VDE 0482-266-2-4
Halogen Free	IEC 60754-1; EN 50267-2-1; DIN VDE 0482-267-2-1; CEI 20-37/2-1 ; BS 6425-1*
No Corrosive Gas Emission	IEC 60754-2; EN 50267-2-2; DIN VDE 0482-267-2-2; CEI 20-37/2-2 ; BS 6425-2*
Minimum Smoke Emission	IEC 61034-1&2; EN 61034 -1&2; DIN VDE 0482-1034-1&2; CEI 20-37/3-1&2; EN 50268-1&2*; BS 7622-1&2*
No Toxic gases	NES 02-713; NF C 20-454

Note: Asterisk * denotes superseded standard.

CABLE CONSTRUCTION

Type/Area of Application	Actuator Sensor Interface
Cable Construction	2x1.5 mm ²
Inner Conductor Diameter	Copper, tinned
Conductor Insulation	Rubber Compound /TPE
Conductor Colors	Blue, brown
Stranding Element	-
Shielding	-
Shielding 2	-
Total Shielding	-
Outer Jacket Material	Thermoplastic LSZH compound
Outer Jacket Color	Yellow /Black

ELECTRICAL DATA:

Conductor Resistance:	27.4 Ohm/km max.
Insulation Resistance	1.00 GOhm x km min.
Working Voltage	Max: 300 V
Test Voltage	1.0 KV at 15 min.

TECHNICAL DATA:

Weight	approximately 57.0 kg/km
Min. Bending Radius (Laying)	6 x OD mm
Operating Temp.Range, min.	- 30 °C
Operating Temp.Range, max.	+90 °C



Reduced Fire Propagation
NF C32-070-2.2(C1)
IEC60332-3-24/EN50266-2-4



Flame Retardancy
NF C32-070-2.1(C2)
IEC60332-1-2/EN50265-2-1



Low Smoke Emission
IEC 61034-1&2
EN 50268-1&2/NF C32-073

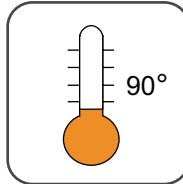

Operating Temperature



Low Toxicity
NES 02-713/NF C 20-454



Low Corrosivity
IEC60754-2
EN50267-2-2/3
NF C 32-074

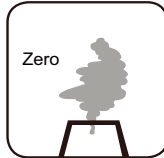

Halogen Free
IEC60754-1
EN50267-2-1



Highly Flexible



Flame Retardant Profibus SK Bus Cables

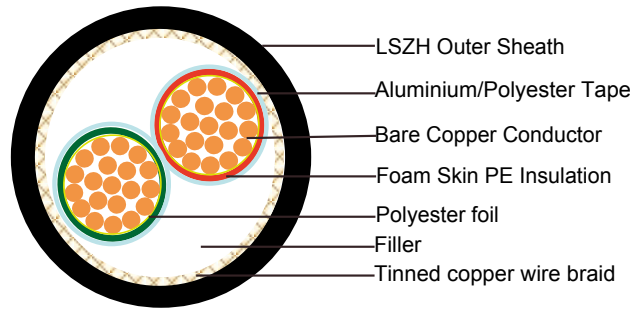
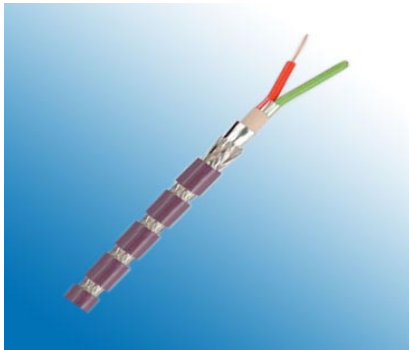

APPLICATION

The application of these Profibus SK cables are in the cell and field area, just as for conventional types. The great advantage of this new system is the quick connection of the cable to the respective plugs. This type of processing also avoids errors. The above mentioned types are suitable for drag chains (stranded). With special design for the outer jacket, the cables are flexible and are suitable for operation at high temperature, protecting this cables from premature aging, while LSZH properties assure low smoke and corrosive gas in the event of a fire.

FIRE PERFORMANCE

Flame Retardance (Single Vertical Wire Test)	EN 60332-1-2; IEC 60332-1-2; BS EN 60332-1-2; VDE 0482-332-1 ; NBN C 30-004 (cat. F1); NF C32-070-2.1(C2); CEI 20-35/1-2; EN 50265-2-1*; DIN VDE 0482-265-2-1*
Reduced Fire Propagation (Vertically-mounted bundled wires & cable test)	EN 60332-3-24 (cat. C); IEC 60332-3-24; BS EN 60332-3-24; VDE 0482-332-3; NBN C 30-004 (cat. F2); NF C32-070-2.2(C1); CEI 20-22/3-4; EN 50266-2-4*; DIN VDE 0482-266-2-4
Halogen Free	IEC 60754-1; EN 50267-2-1; DIN VDE 0482-267-2-1; CEI 20-37/2-1 ; BS 6425-1*
No Corrosive Gas Emission	IEC 60754-2; EN 50267-2-2; DIN VDE 0482-267-2-2; CEI 20-37/2-2 ; BS 6425-2*
Minimum Smoke Emission	IEC 61034-1&2; EN 61034 -1&2; DIN VDE 0482-1034-1&2; CEI 20-37/3-1&2; EN 50268-1&2*; BS 7622-1&2*
No Toxic gases	NES 02-713; NF C 20-454

Note: Asterisk * denotes superseded standard.

CABLE CONSTRUCTION







Type	Profibus SK
Cable Construction	1x2x0.64 mm (stranded)
Inner Conductor Diameter	Copper, bare (AWG 24/19)
Conductor Insulation	Foam-skin-PE
Conductor Colors	red, green
Stranding Element	2 conductors + filler
Wrapping	Polyester foil over stranded bundle
Shielding	Polyester foil, aluminum-lined
Total Shielding	Copper braid, tinned
Outer Jacket Material	Thermoplastic LSZH compound
Outer Diameter	8.0 mm ± 0.4 mm
Outer Jacket Color	Violet

ELECTRICAL DATA:

Characteristic Impedance@3-20Hz	100 Ω ± 20 Ω
Conductor Resistance	24.0 Ohm/km max.
Insulation Resistance	1.00 GOhm x km min.
Mutual Capacitance@1KHz	60.0 nF/km nom.
Working Voltage	300 V
Test Voltage	1.0 KV /2.5 kV
Attenuation:	9.6KHZ < 3dB/kmTest
	38.4KHZ < 5dB/kmTest
	4KHZ < 25dB/kmTest
	16KHZ < 52dB/kmTest

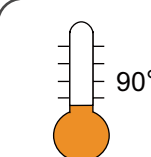
TECHNICAL DATA:

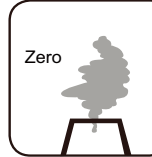
Weight	approximately 70.0 kg/km
Min. Bending Radius (Laying)	7.5x OD mm
Operating Temp.Range, min.	- 30 °C
Operating Temp.Range, max.	+90 °C

 Reduced Fire Propagation NF C32-070-2.2(C1) IEC60332-3-24/EN50266-2-4	 Flame Retardancy NF C32-070-2.1(C2) IEC60332-1-2/EN50265-2-1	 Low Smoke Emission IEC 61034-1&2 EN 50268-1&2/NF C32-073	 Operating Temperature
 Low Toxicity NES 02-713/NF C 20-454	 Low Corrosivity IEC60754-2 EN50267-2-2/3 NF C 32-074	 Halogen Free IEC60754-1 EN50267-2-1	 Highly Flexible



Flame Retardant Plastic Optical Fiber Cables

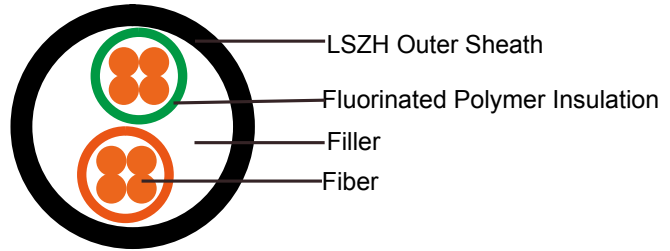

APPLICATION

1. Signal transmission of sensors;
2. High speed data transmission;
3. Industrial control data links;
4. Military communication;
5. Proprietary LANs or Access Network;
6. Multi-media data link and plant control in vehicles and airplanes;

FIRE PERFORMANCE

Flame Retardance (Single Vertical Wire Test)	EN 60332-1-2; IEC 60332-1-2; BS EN 60332-1-2; VDE 0482-332-1 ; NBN C 30-004 (cat. F1); NF C32-070-2.1(C2); CEI 20-35/1-2; EN 50265-2-1*; DIN VDE 0482-265-2-1*
Reduced Fire Propagation (Vertically-mounted bundled wires & cable test)	EN 60332-3-24 (cat. C); IEC 60332-3-24; BS EN 60332-3-24; VDE 0482-332-3; NBN C 30-004 (cat. F2); NF C32-070-2.2(C1); CEI 20-22/3-4; EN 50266-2-4*; DIN VDE 0482-266-2-4
Halogen Free	IEC 60754-1; EN 50267-2-1; DIN VDE 0482-267-2-1; CEI 20-37/2-1 ; BS 6425-1*
No Corrosive Gas Emission	IEC 60754-2; EN 50267-2-2; DIN VDE 0482-267-2-2; CEI 20-37/2-2 ; BS 6425-2*
Minimum Smoke Emission	IEC 61034-1&2; EN 61034 -1&2; DIN VDE 0482-1034-1&2; CEI 20-37/3-1&2; EN 50268-1&2*; BS 7622-1&2*
No Toxic gases	NES 02-713; NF C 20-454

Note: Asterisk * denotes superseded standard.

CABLE CONSTRUCTION

Plastic Optical Fiber Cable, also named polymer optical fiber, which is used for lighting and communications:

Cladding Material: Fluorinated Polymer

Jacketing Material: PE or PVC

Optical Instruction: Step Index Model

Numerical Aperture: 0.5

Allowable Bend Radius: No less than ten times of optical fiber diameter

Core Refractive Index: 1.492

ELECTRICAL PROPERTIES

1. Attenuation <math><0.18\text{dB/m}</math> @ 650nm;
2. Theoretic bandwidth of
10~20MHz. 50m(Numerical aperture 0.5),
100~200MHz. 50m(Numerical aperture 0.3);
3. Diameter allowance $\pm 3\%$ in actual production;
4. Working temperature: --454~80 Celsius Degrees;
5. Jacketing material: PE or PVC

PHYSICAL AND THERMAL PROPERTIES

Temperature range during operation (fixed state): -30°C - +90°C

Minimum bending radius: 15 x Overall Diameter

TECHNICAL DATA:

Model	Fiber Dia. (mm)	Jacketing Materials	Max. Attenuation (dB/m)	N. A	Working Temperature (Celsius Degrees)	Spool Length (m)	Dia. Allowance ($\pm \%$)
CC2-500	0.5	PE	0.18	0.5	-45~80	1000/6000	$\pm 3\%$
CC2-750	0.75	PE	0.18	0.5	-45~80	2700	$\pm 3\%$
CC2-1000	1.0	PE	0.18	0.5	-45~80	1500/2500	$\pm 3\%$



Reduced Fire Propagation
NF C32-070-2.2(C1)

IEC60332-3-24/EN50266-2-4



Flame Retardancy
NF C32-070-2.1(C2)

IEC60332-1-2/EN50265-2-1



Low Smoke Emission
IEC 61034-1&2

EN 50268-1&2/NF C32-073

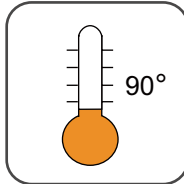

Operating Temperature



Low Toxicity

NES 02-713/NF C 20-454



Low Corrosivity
IEC60754-2
EN50267-2-2/3
NF C 32-074

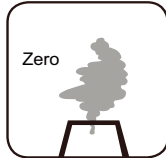

Halogen Free
IEC60754-1
EN50267-2-1



Highly Flexible



Flame Retardant Tight Buffered Distribution Fiber Optic Cables

MTA-B-C-D-H

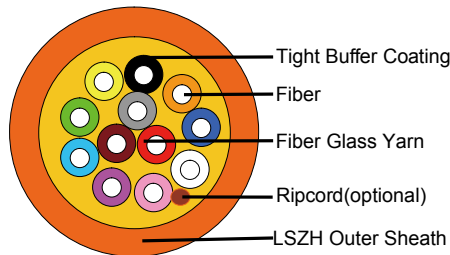

APPLICATION

This cables are used for interconnection of distribution boxes and end devices, where continued functionality is required during a fire situation. The cables are very suitable for various indoor and outdoor applications, including routing between buildings within ducts and inside building up to riser shafts.

STANDARDS

Basic design to Telcordia GR409-CORE / TIA/EIA 568B.3 / ICEA-S-83-596

FIRE PERFORMANCE

Flame Retardance (Single Vertical Wire Test)	EN 60332-1-2; IEC 60332-1-2; BS EN 60332-1-2; VDE 0482-332-1 ; NBN C 30-004 (cat. F1); NF C32-070-2.1(C2); CEI 20-35/1-2; EN 50265-2-1*; DIN VDE 0482-265-2-1*
Reduced Fire Propagation (Vertically-mounted bundled wires & cable test)	EN 60332-3-24 (cat. C); IEC 60332-3-24; BS EN 60332-3-24; VDE 0482-332-3; NBN C 30-004 (cat. F2); NF C32-070-2.2(C1); CEI 20-22/3-4; EN 50266-2-4*; DIN VDE 0482-266-2-4
Halogen Free	IEC 60754-1; EN 50267-2-1; DIN VDE 0482-267-2-1; CEI 20-37/2-1 ; BS 6425-1*
No Corrosive Gas Emission	IEC 60754-2; EN 50267-2-2; DIN VDE 0482-267-2-2; CEI 20-37/2-2 ; BS 6425-2*
Minimum Smoke Emission	IEC 61034-1&2; EN 61034 -1&2; DIN VDE 0482-1034-1&2; CEI 20-37/3-1&2; EN 50268-1&2*; BS 7622-1&2*
No Toxic gases	NES 02-713; NF C 20-454

Note: Asterisk * denotes superseded standard.

CABLE CONSTRUCTION

Optical fibers: Singlemode and multimode tight fibers, with tight buffer coating.

Reinforcement: Either aramid yarn or fiber glass is wound around the tube to provide physical protection and tensile strength, with added fire protection.

Inner Sheath(optional): Thermoplastic LSZH compound type LTS3 as per BS 7655-6.1

Ripcord(optional): An optional ripcord can be located under the outer sheath to facilitate jacket removal.

Armouring(optional):

STA: Corrugated steel tape armour

SWB: Steel wire braid

Outer Sheath: Thermoplastic LSZH compound type LTS3 as per BS 7655-6.1 (Thermosetting LSZH compound type SW2-SW4 as per BS 7655-2.6 can be offered.)

PHYSICAL AND THERMAL PROPERTIES

Temperature range during operation (fixed state): -30°C - +90°C

Temperature range during installation (mobile state): 0°C - +50°C

Minimum bending radius: 10 times the outer diameter for unarmoured cables
20 times the outer diameter for armoured cables

CONSTRUCTION PARAMETERS

Cable Code	N° of Fibers	Nominal Overall Diameter	Max. Tensile Strength	Minimum Bending Radius	Approx. Weight
		mm	N	mm	kg/km
MTA-B-2-0-H	2	7,6	250	76	55
MTA-B-4-0-H	4	7,8	250	78	67
MTA-B-6-0-H	6	8,6	400	86	77
MTA-B-8-0-H	8	8,8	400	88	81
MTA-B-12-0-H	12	9,3	400	93	90

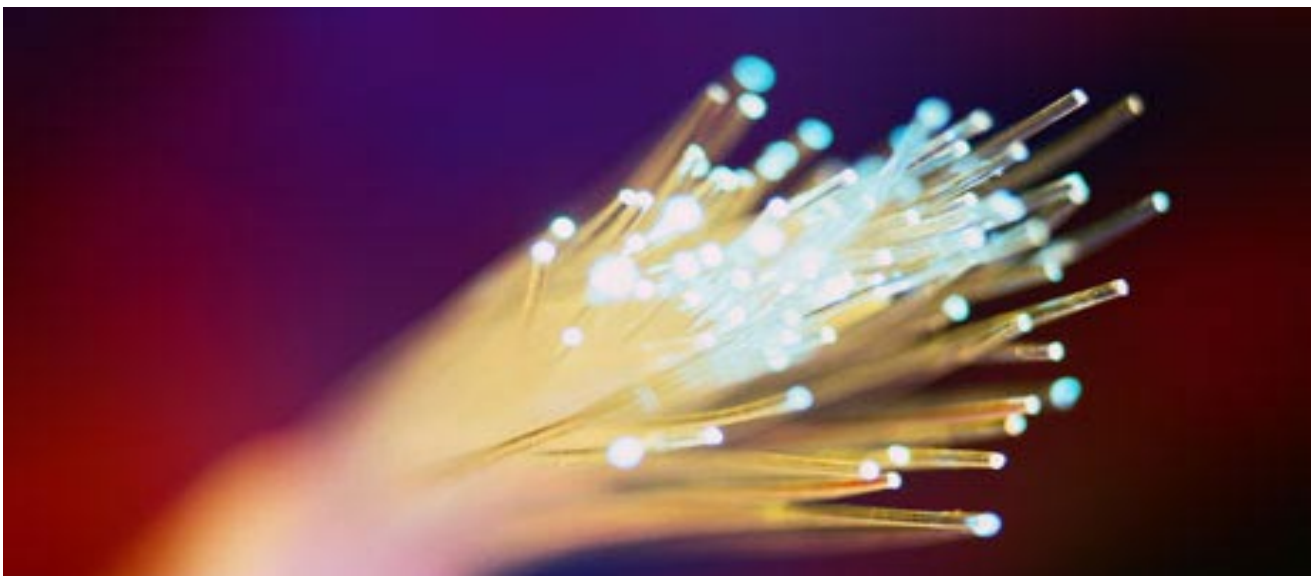



Caledonian

Flame Retardant Optic Fiber Cables

www.caledonian-cables.co.uk www.addison-cables.com



TYPE CODES

MTA-B-C-D-E-F-G-H

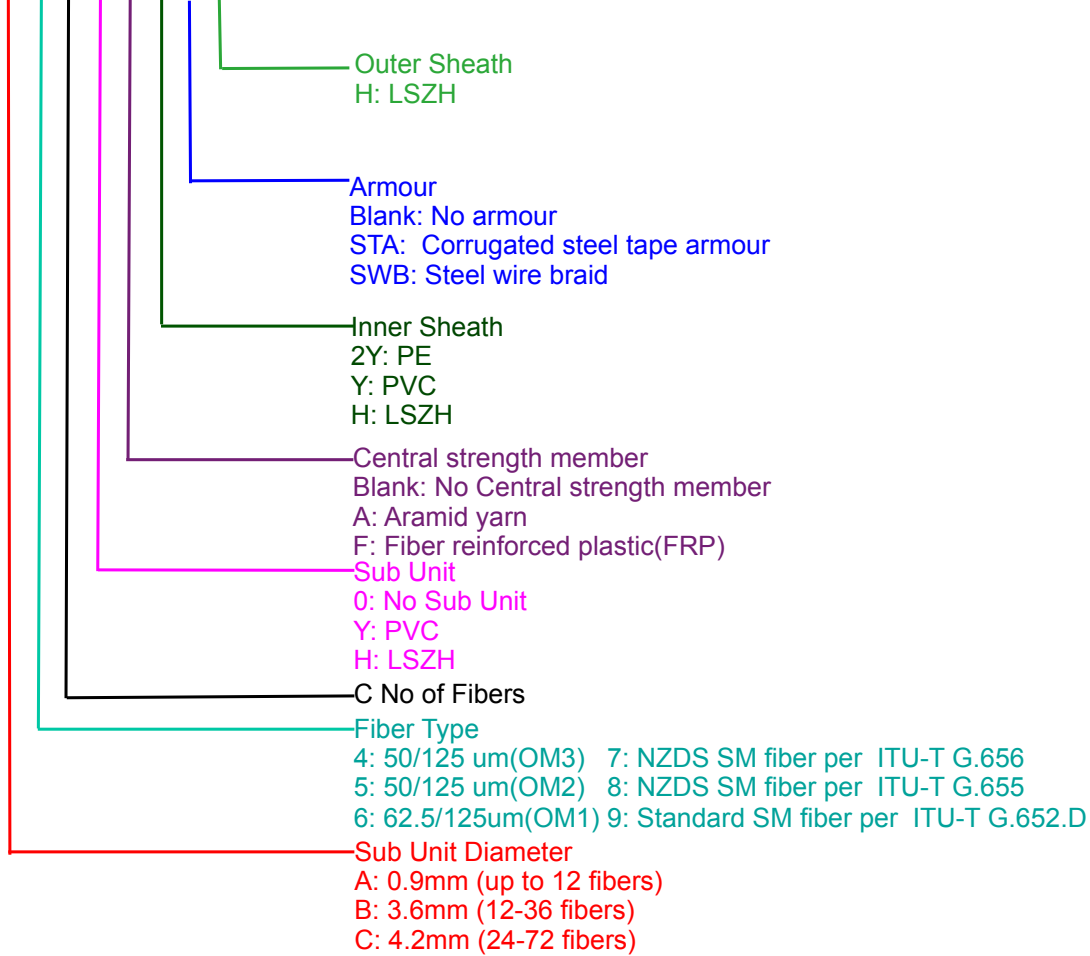

Standard



Standard



Reduced Fire Propagation
NF C32-070-2.2(C1)
IEC60332-3-24/EN50266-2-4



Flame Retardancy
NF C32-070-2.1(C2)

IEC60332-1-2/EN50265-2-1

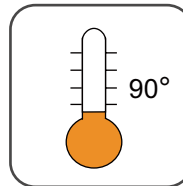

Operating Temperature



Low Toxicity
NES 02-713/NF C 20-454



Low Corrosivity
IEC60754-2
EN50267-2-2/3
NF C 32-074



Low Smoke Emission
IEC 61034-1&2
EN 50268-1&2/NF C32-073

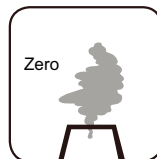

Zero
Halogen Free
IEC60754-1
EN50267-2-1



Highly Flexible

Flame Retardant Central Loose Tube Fiber Optic Cables

APPLICATION

These cables are characterized by light weight and small diameter, suitable for both aerial and duct installation. They are mainly installed inside buildings, tunnels, subways or closed areas in general, specially designed to guarantee the signal transmission even in case of fire. The cable can also be used for direct burial for armoured version.

STANDARDS

Basic design to Telcordia GR-20 / RUS 7 CFR 1755.900 (REA PE-90) / ICEA S 87-640

FIRE PERFORMANCE

Flame Retardance (Single Vertical Wire Test)	EN 60332-1-2; IEC 60332-1-2; BS EN 60332-1-2; VDE 0482-332-1 ; NBN C 30-004 (cat. F1); NF C32-070-2.1(C2); CEI 20-35/1-2; EN 50265-2-1*; DIN VDE 0482-265-2-1*
Reduced Fire Propagation (Vertically-mounted bundled wires & cable test)	EN 60332-3-24 (cat. C); IEC 60332-3-24; BS EN 60332-3-24; VDE 0482-332-3; NBN C 30-004 (cat. F2); NF C32-070-2.2(C1); CEI 20-22/3-4; EN 50266-2-4*; DIN VDE 0482-266-2-4
Halogen Free	IEC 60754-1; EN 50267-2-1; DIN VDE 0482-267-2-1; CEI 20-37/2-1 ; BS 6425-1*
No Corrosive Gas Emission	IEC 60754-2; EN 50267-2-2; DIN VDE 0482-267-2-2; CEI 20-37/2-2 ; BS 6425-2*
Minimum Smoke Emission	IEC 61034-1&2; EN 61034 -1&2; DIN VDE 0482-1034-1&2; CEI 20-37/3-1&2; EN 50268-1&2*; BS 7622-1&2*
No Toxic gases	NES 02-713; NF C 20-454

Note: Asterisk * denotes superseded standard.

CABLE CONSTRUCTION

Fibers: Singlemode and multimode fibers, with loose tube technology.

Structure: Central loose tube cable contains one tube with 2-24 single or multimode fibers, which are filled with water blocking gel.

Water blocking: The jelly filled tube is waterblocked by using swellable tape and thread.

Reinforcement: Either aramid yarn or fiber glass is wound around the tube to provide physical protection and tensile strength, with added fire protection.

Inner Sheath (optional): The cable can be jacketed with either PE or thermoplastic LSZH inner sheath. PE is the preferred option in outdoor environment for water protection purpose.

Moisture Barrier Tape (optional): An aluminum moisture tape can be incorporated under the sheath for water blocking and shielding purpose.

Armouring(optional):

For direct burial, either galvanized steel wire braid, corrugated steel tape armour or galvanized steel wire armour is applied over an inner polyethylene or LSZH sheath. For steel tape armour, the 0.15mm thick steel tape is coated with a copolymer and applied with an overlap. For steel wire braid or armour, single layer of galvanized steel wire braid or armour is applied.

Ripcord (optional): An optional ripcord can be located under the jacket to facilitate jacket removal.



Outer Sheath: Thermoplastic LSZH compound type LTS3 as per BS 7655-6.1 (Thermosetting LSZH compound type SW2-SW4 as per BS 7655-2.6 can be offered.)

FIBER COLOUR CODE

Fiber colour code	1	Red	7	Brown
	2	Green	8	Violet
	3	Blue	9	Turquoise
	4	Yellow	10	Black
	5	White	11	Orange
	6	Grey	12	Pink

CONSTRUCTION

UNARMoured TYPE

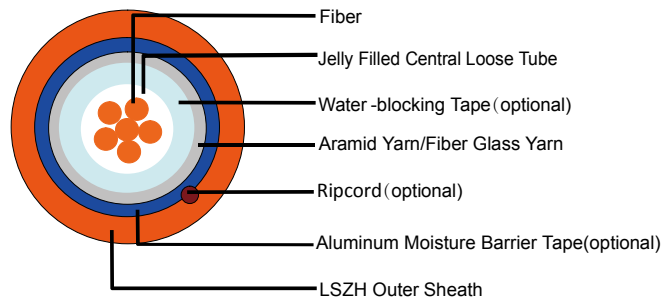
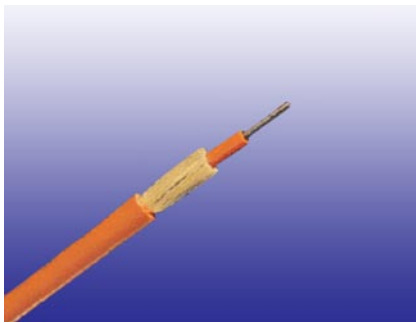

CONSTRUCTION PARAMETERS

Cable Code	Fiber Count	Tube Diameter	Nominal Overall Diameter	Approx. Weight	Tension load	Crush
	(n°)	mm	mm	kg/km	N	N/100mm
CLA-B-C-H-J	02-06	2.7	8.0	70	1000	1500
CLA-B-C-H-J	08-16	3.5	9.0	90	1200	1500
CLA-B-C-H-J	18-24	4.2	10.0	100	1500	1500

STEEL WIRE BRAID

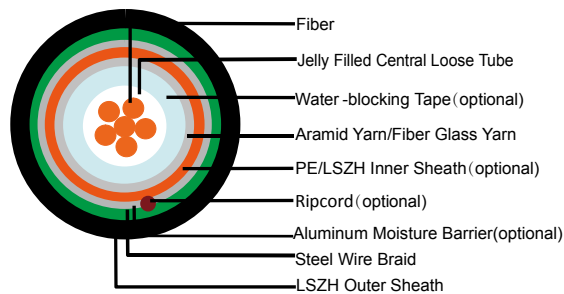

CONSTRUCTION PARAMETERS

Cable Code	Fiber Count	Tube Diameter	Nominal Overall Diameter	Approx. Weight	Tension load	Crush
	(n°)	mm	mm	kg/km	N	N/100mm
CLA-B-C-2Y(SWB)H-J	02-06	2.7	11.5	160	1000	2000
CLA-B-C-2Y(SWB)H-J	08-16	3.5	12.0	180	1200	2000
CLA-B-C-2Y(SWB)H-J	18-24	4.2	13.0	200	1500	2000

CORRUGATED STEEL TAPE ARMOUR

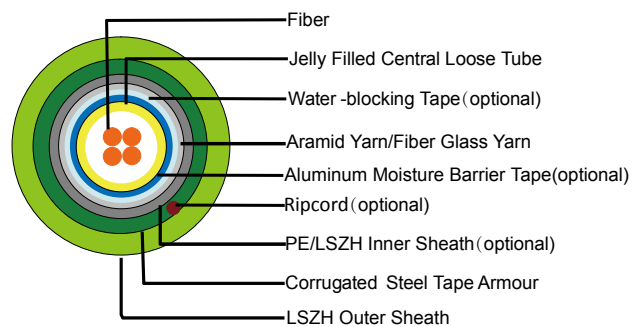
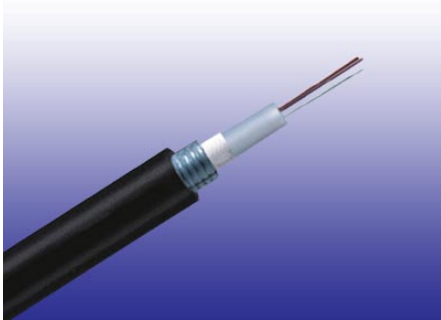

CONSTRUCTION PARAMETERS

Cable Code	Fiber Count	Tube Diameter	Diameter	Approx. Weight	Tension load	Crush
	(n°)	mm	mm	kg/km	N	N/100mm
CLA-B-C-2Y(STA)H-J	02-06	2.7	13.0	200	1000	2500
CLA-B-C-2Y(STA)H-J	08-16	3.5	14.0	220	1200	2500
CLA-B-C-2Y(STA)H-J	18-24	4.2	14.5	250	1500	2500

STEEL WIRE ARMOUR

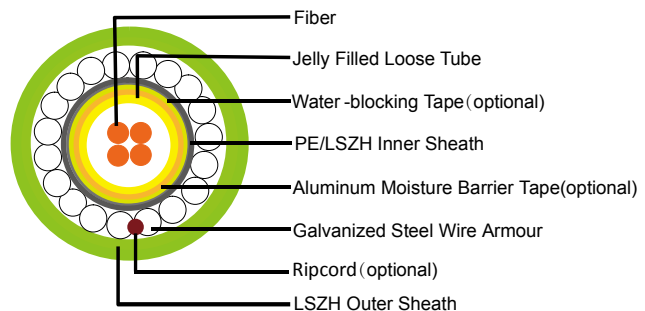
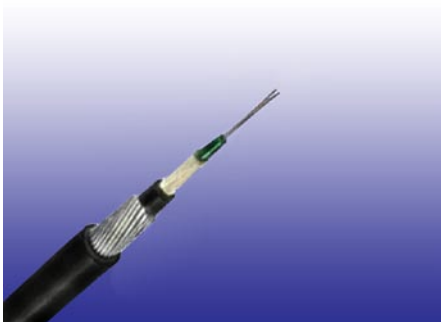



CONSTRUCTION PARAMETERS

Cable Code	Fiber Count	Tube Diameter	Nominal Overall Diameter	Approx. Weight	Tension load	Crush
	(n°)	mm	mm	kg/km	N	N/100mm
CLA-B-C-2Y(SWA)H-J	02-12	2.7	10.5	180	2500	4000
CLA-B-C-2Y(SWA)H-J	16-24	3.5	11.0	210	2500	4000

PHYSICAL AND THERMAL PROPERTIES

Temperature range during operation (fixed state): -30°C - +90°C

Temperature range during installation (mobile state): 0°C - +50°C

Minimum Operation Bending Radius: 10 times the outer diameter for unarmoured cables
20 times the outer diameter for armoured cables

Minimum Installation Bending Radius: 20 times the outer diameter

MECHANICAL PROPERTIES

Maximum Compressive Load	4000N for unarmoured cables 5000N for armoured cables
Repeated Impact:	4.4 N.m (J)
Twist (Torsion):	180×10 times, 125×OD
Cyclic Flexing:	25 cycles for armoured cables; 100 cycles for unarmoured cables.
Crush Resistance:	263N/cm (150lb/in)

FIBER COMPLIANCE

Temperature Cycling	IEC60794-1-2-F2
Tensile Strength	IEC60794-1-2-E1A
Crush	IEC60794-1-2-E3
Impact	IEC60794-1-2-E4
Repeated Bending	IEC60794-1-2-E6
Torsion	IEC60794-1-2-E7
Kink	IEC60794-1-2-E10
Cable Bend	IEC60794-1-2-E11
Cool Bend	IEC60794-1-2-E11

TYPE CODES

CLA-B-C-D-E-F-G

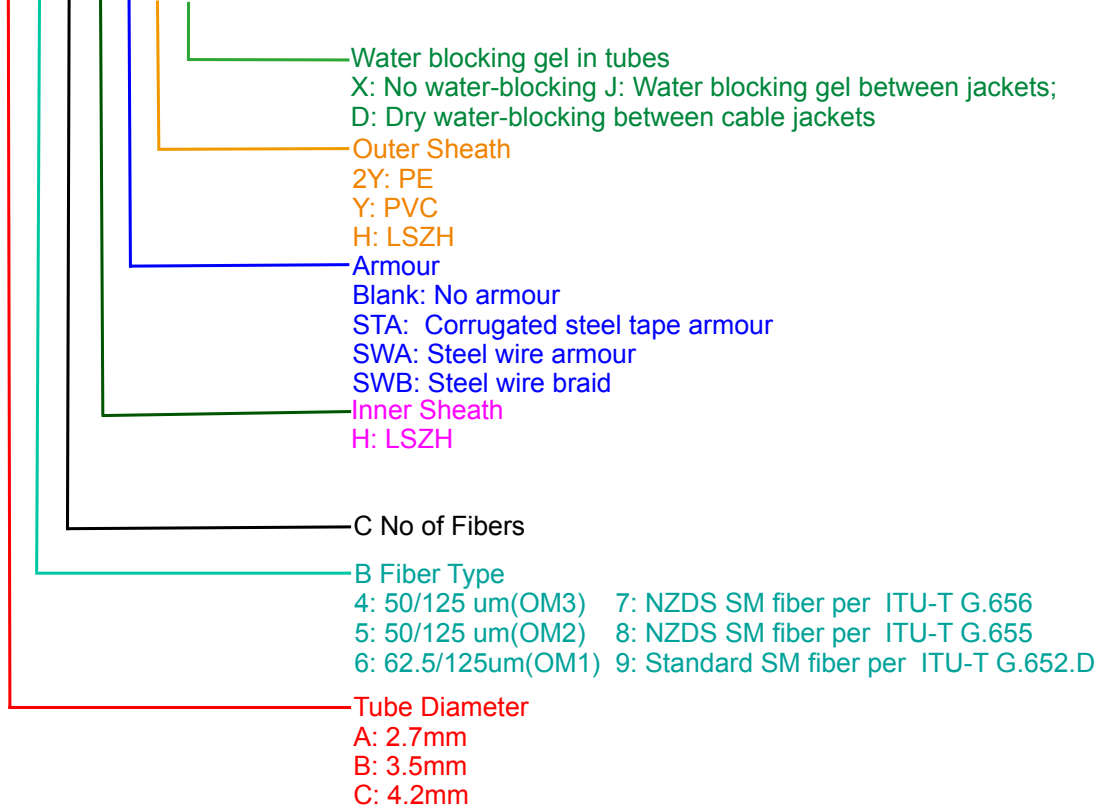

Standard



Standard



Reduced Fire Propagation
NF C32-070-2.2(C1)
IEC60332-3-24/EN50266-2-4



Flame Retardancy
NF C32-070-2.1(C2)
IEC60332-1-2/EN50265-2-1

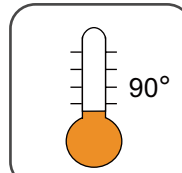

Operating Temperature



Low Toxicity
NES 02-713/NF C 20-454



Low Corrosivity
IEC60754-2
EN50267-2-2/3
NF C 32-074



Low Smoke Emission
IEC 61034-1&2
EN 50268-1&2/NF C32-073

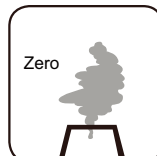

Halogen Free
IEC60754-1
EN50267-2-1



Highly Flexible



Flame Retardant Multi Loose Tube Fiber Optic Cables

APPLICATION

The multi loose tube non metallic cables are designed for outside plant, which is prone to electrical interference. They are mainly installed inside buildings, tunnels,subways or closed areas in general, specially designed to guarantee the signal transmission even in case of fire. The cable can also be used for direct burial for armoured version.

STANDARDS

Basic design to Telcordia GR-20 / RUS 7 CFR 1755.900 (REA PE-90) / ICEA S 87-640

FIRE PERFORMANCE

Flame Retardance (Single Vertical Wire Test)	EN 60332-1-2; IEC 60332-1-2; BS EN 60332-1-2; VDE 0482-332-1 ; NBN C 30-004 (cat. F1); NF C32-070-2.1(C2); CEI 20-35/1-2; EN 50265-2-1*; DIN VDE 0482-265-2-1*
Reduced Fire Propagation (Vertically-mounted bundled wires & cable test)	EN 60332-3-24 (cat. C); IEC 60332-3-24; BS EN 60332-3-24; VDE 0482-332-3; NBN C 30-004 (cat. F2); NF C32-070-2.2(C1); CEI 20-22/3-4; EN 50266-2-4*; DIN VDE 0482-266-2-4
Halogen Free	IEC 60754-1; EN 50267-2-1; DIN VDE 0482-267-2-1; CEI 20-37/2-1 ; BS 6425-1*
No Corrosive Gas Emission	IEC 60754-2; EN 50267-2-2; DIN VDE 0482-267-2-2; CEI 20-37/2-2 ; BS 6425-2*
Minimum Smoke Emission	IEC 61034-1&2; EN 61034 -1&2; DIN VDE 0482-1034-1&2; CEI 20-37/3-1&2; EN 50268-1&2*; BS 7622-1&2*
No Toxic gases	NES 02-713; NF C 20-454

Note: Asterisk * denotes superseded standard.

CABLE CONSTRUCTION

Fibers: Singlemode and multimode fibers, with loose tube technology.

Structure: The cable consists of 5 to 36 fibers containing tubes or fillers stranded in up to 3 layers around a central strength member and bound under a LSZH sheath. Each tube contains 4 -12 fibers, which is filled with water blocking gel.

Central Strength Member: Solid or stranded steel wire coated with polyethylene is usually used as central strength member. Fiber glass reinforced plastics (FRP) will be used as central strength member if non metallic construction is required.

Water Blocking: The jelly filled tube is waterblocked by using swellable tape and thread.

Reinforcement: Either aramid yarn or fiber glass is wound around the tube to provide physical protection and tensile strength, with added fire protection.

Inner Sheath (optional): The cable can be jacketed with either PE or Thermoplastic LSZH inner sheath. PE is the preferred option in outdoor environment for water protection purpose.

Armouring(optional): For diect burial, either galvanized steel wire braid, corrugated steel tape armour or galvanized steel wire armour is applied over an inner polyethylene or LSZH sheath.

For steel tape armour, the 0.15mm thick steel tape is coated with a copolymer and applied with an overlap. For steel wire braid or armour, single layer of galvanized steel wire braid or armour is applied.

Moisture Barrier Tape (optional): An aluminum moisture tape can be incorporated under the sheath for water blocking and shielding purpose.

Ripcord (optional): An optional ripcord can be located under the jacket to facilitate jacket removal.

Outer Sheath: Thermoplastic LSZH compound type LTS3 as per BS 7655-6.1 (Thermosetting LSZH compound type SW2-SW4 as per BS 7655-2.6 can be offered.)

FIBER COLOUR CODE

Fiber colour code	1	Red	7	Brown
	2	Green	8	Violet
	3	Blue	9	Turquoise
	4	Yellow	10	Black
	5	White	11	Orange
	6	Grey	12	Pink

CONSTRUCTION

UNARMoured TYPE

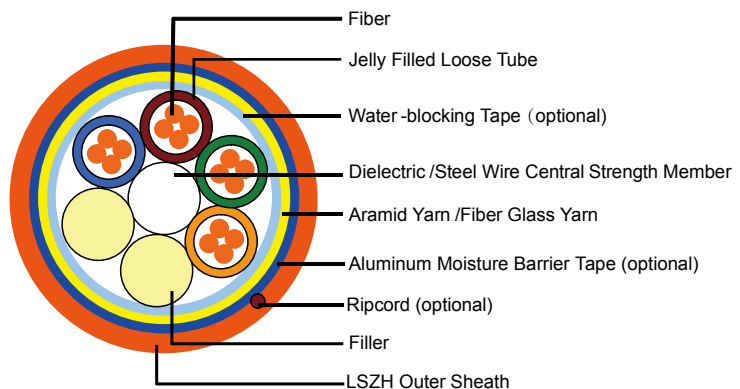
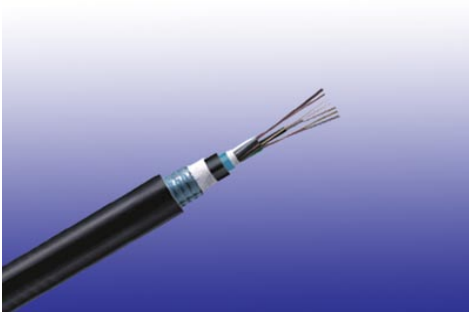

CONSTRUCTION PARAMETERS

Cable Code	Fiber Count	Tube Diameter	Nominal Overall Diameter	Approx. Weight	Tension load	Crush
	(n°)	mm	mm	kg/km	N	N/100mm
MLA-B-C×D-F-H-J	72	2.5	15.0	230	4000	3000
MLA-B-C×D-F-H-J	96	2.5	16.5	250	4000	3000
MLA-B-C×D-F-H-J	144	2.5	20.5	280	4000	3000



STEEL WIRE BRAID

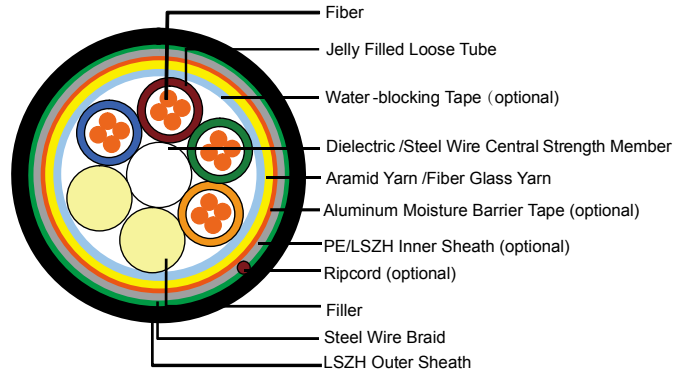

CONSTRUCTION PARAMETERS

Cable Code	Fiber Count	Tube Diameter	Nominal Overall Diameter	Approx. Weight	Tension load	Crush
	(n°)	mm	mm	kg/km	N	N/100mm
MLA-B-C×D-F-2Y(SWB)H-J	72	2.5	15.0	280	3000	3500
MLA-B-C×D-F-2Y(SWB)H-J	96	2.5	17.5	310	3000	3500
MLA-B-C×D-F-2Y(SWB)H-J	144	2.5	21.5	350	3500	3500

CORRUGATED STEEL TAPE ARMOUR

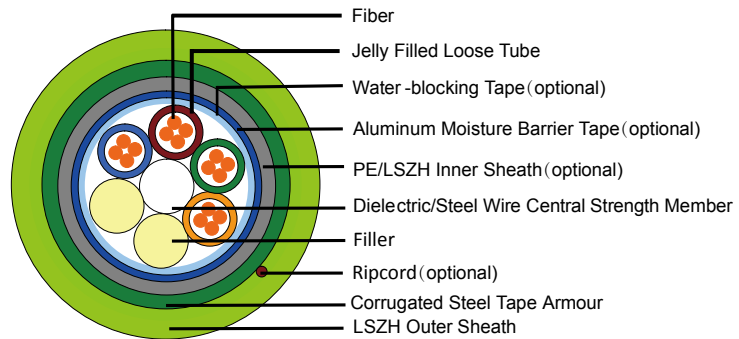

CONSTRUCTION PARAMETERS

Cable Code	Fiber Count	Tube Diameter	Nominal Overall Diameter	Approx. Weight	Tension load	Crush
	(n°)	mm	mm	kg/km	N	N/100mm
MLA-B-C×D-F-2Y(STA)H-J	72	2.5	16.5	290	3000	7500
MLA-B-C×D-F-2Y(STA)H-J	96	2.5	18.5	350	3000	7500
MLA-B-C×D-F-2Y(STA)H-J	144	2.5	22.5	450	3500	7500

STEEL WIRE ARMOUR

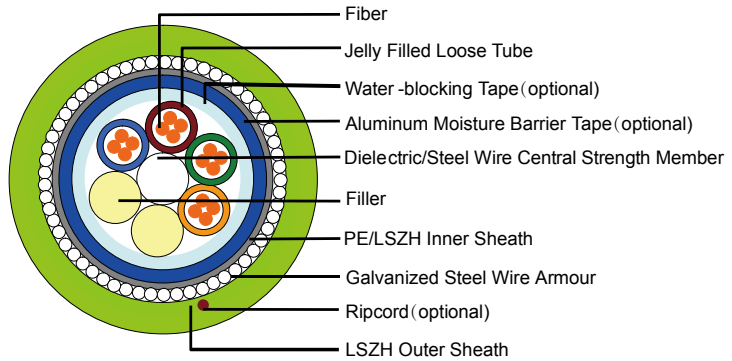
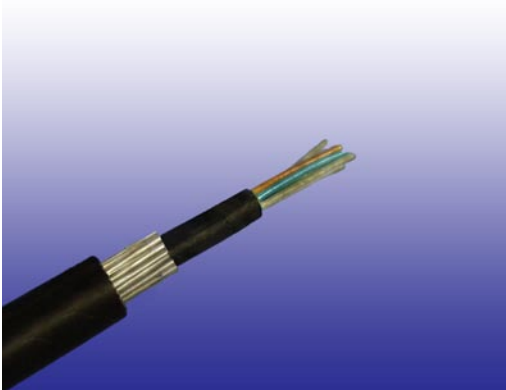

CONSTRUCTION PARAMETERS

Cable Code	Fiber Count	Tube Diameter	Nominal Overall Diameter	Approx. Weight	Tension load	Crush
	(n°)	mm	mm	kg/km	N	N/100mm
MLA-B-C×D-F-2Y(SWA)H-J	72	2.0	15.0	360	3500	5000
MLA-B-C×D-F-2Y(SWA)H-J	96	2.0	16.5	390	4000	5000
MLA-B-C×D-F-2Y(SWA)H-J	144	2.0	18.5	430	4500	5000

PHYSICAL AND THERMAL PROPERTIES

Temperature range during operation (fixed state): -30°C - +90°C

Temperature range during installation (mobile state): 0°C - +50°C

Minimum Installation Bending Radius: 20 times the outer diameter

Minimum Operation Bending Radius: 10 times the outer diameter for unarmoured cables

20 times the outer diameter for armoured cables



MECHANICAL PROPERTIES

Maximum Compressive Load:	4000N for unarmoured cables 6000N for armoured cables
Repeated Impact:	4.4 N.m (J)
Twist (Torsion):	180×10 times, 125×OD
Cyclic Flexing:	25 cycles for armoured cables 100 cycles for unarmoured cables
Crush Resistance:	220N/cm(125lb/in)

FIBER COMPLIANCE

Temperature Cycling	IEC60794-1-2-F2
Tensile Strength	IEC60794-1-2-E1A
Crush	IEC60794-1-2-E3
Impact	IEC60794-1-2-E4
Repeated Bending	IEC60794-1-2-E6
Torsion	IEC60794-1-2-E7
Kink	IEC60794-1-2-E10
Cable Bend	IEC60794-1-2-E11
Cool Bend	IEC60794-1-2-E11

TYPE CODES

MLA-B-CxD-E-F-G-H-I

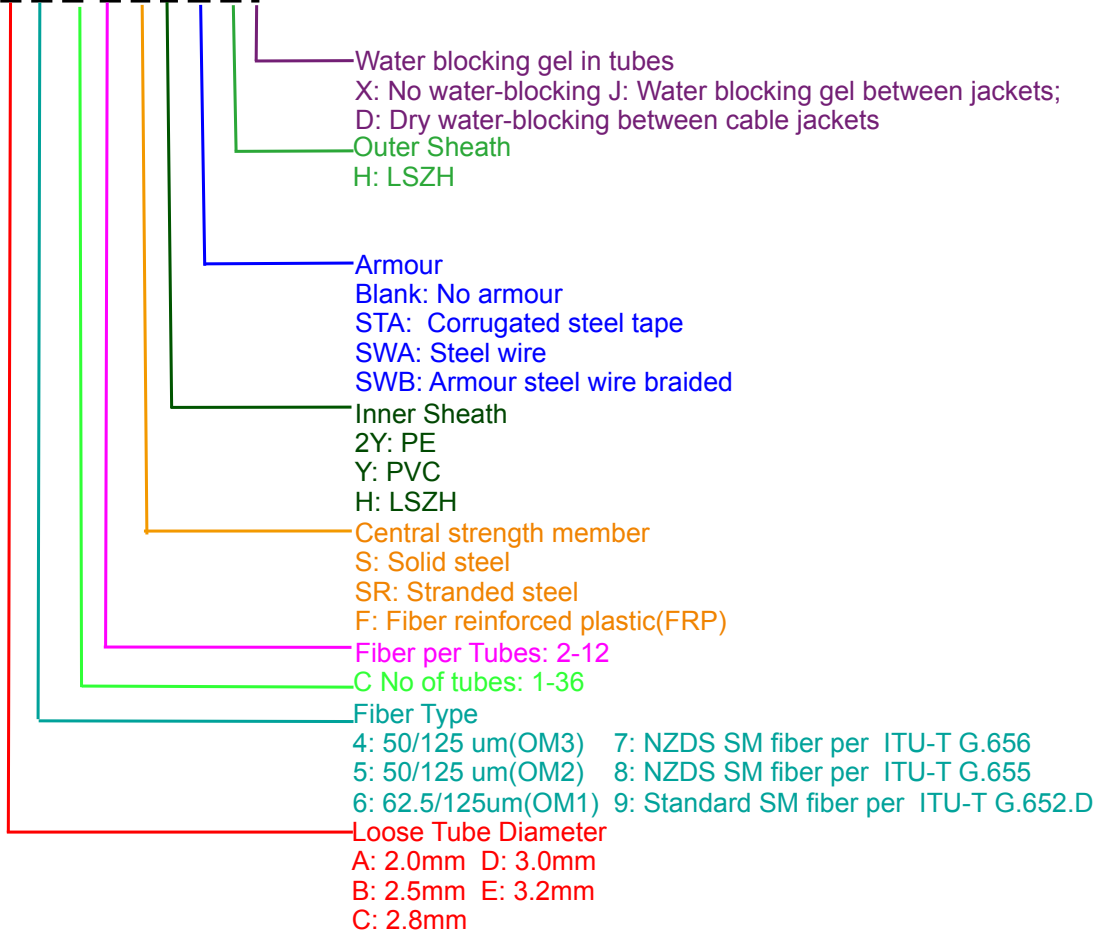

Standard



Standard



Reduced Fire Propagation
NF C32-070-2.2(C1)



Flame Retardancy
NF C32-070-2.1(C2)

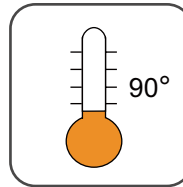

Operating Temperature



Low Toxicity
NES 02-713/NF C 20-454



Low Corrosivity
IEC60754-2
EN50267-2-2/3
NF C 32-074



Low Smoke Emission
IEC 61034-1&2
EN 50268-1&2/NF C32-073

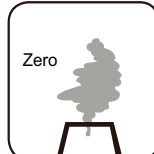

Halogen Free
IEC60754-1
EN50267-2-1



Highly Flexible



Technical Information For Fiber Optic Cables

Optical & Geometrical Properties for Single Mode Fibers

Parameter		Standard Single Mode Fiber per ITU-T G.652D	Non-zero Dispersion Shifted fiber per ITU-T G.655	Non-zero Dispersion Shifted fiber per ITU-T G.656	Units
Fiber Code		9	8	7	
Attenuation, Loose Tube Cables		Standard	Metro Area	Long Haul	
	@1310nm	≤0.35	-	-	dB/km
	@1550nm	≤0.22	≤0.22	≤0.22	dB/km
	@1625nm	≤0.25	≤0.26	≤0.26	dB/km
Attenuation, Tight Buffer or Semi-Tight Cables					
	@1310nm	≤0.38	-	-	dB/km
	@1550nm	≤0.28	-	-	dB/km
Chromatic Dispersion	between 1260 and 1360nm (O Band)	≤3.5	NA-	-	ps/(nm*km)
	between 1460 and 1530nm (S Band)	-	-	2.0-7.0	ps/(nm*km)
	between 1530 and 1565nm (C Band)	≤18	1.0-10.0	7.0-10.0	ps/(nm*km)
	between 1565 and 1625nm (L Band)	≤22	7.0-12.0	10.0-14.0	ps/(nm*km)
Zero Dispersion Wavelength		1310±11	≤1520	≤1420	nm
Zero Dispersion Slope		0.093	0.093	0.093	ps/(nm ² .km)
Point Discontinuity at 1300nm & 1550nm		0.1	0.1	0.1	dB
Mode Field Diameter	@1300nm	9.3±0.5	-	-	um
	@1550nm	10.4±0.8	8.5±0.6	9.0±0.5	um
Cable Cut-off Wavelength		≤1260	≤1450	≤1310	nm
PMD (Individual fiber)		≤0.2	≤0.2	≤0.2	ps/km 1/2
Cladding Diameter		125±1	125±1	125±1	um

Core/Cladding Concentricity Error	≤0.5	≤0.5	≤0.6	um
Cladding Non-Circularity	≤1.0	≤1.0	≤1.0	%
Coating Non-Circularity	≤6.0	≤6.0	≤6.0	%
Primary Coating Diameter	245±10	245±10	245±10	um
Proof-Test Level	100 (0.7)	100 (0.7)	100 (0.7)	Kpsi/GN/m ²
Fatigue Coefficient	≥20	≥20	≥20	
Temperature Dependence between 0°C ~ +70°C @ 1310 & 1550nm	0.1	0.1	0.1	Db/km

Optical & Geometrical Properties for Multimode Fibers

Parameter		50/125		62.5/125	Units
Fiber Code		5	4	6	-
ISO/IEC 11801 Classification(2)		OM2	OM3	OM1	-
Attenuation, Loose Tube Cables					
@850nm		≤3.0		≤3.0	dB/km
@1300nm		≤0.8		≤0.8	dB/km
Attenuation, Tight Buffer and Semi-tight Cables					
@850nm		≤3.0		≤3.5	dB/km
@1300nm		≤1.0		≤1.0	dB/km
Bandwidth*	@850nm	≥500	≥2000	≥200	MHz*km
	@1300nm	≥800/500	≥500	≥500/600	MHz*km
Numerical Aperture		0.20±0.015		0.275±0.015	-
Core Diameter		50±3		62.5±3	um
Cladding Diameter		125±2		125±2	um
Core/Cladding Concentricity		≤1.5		≤1.5	um
Core Non-Circularity		≤6		≤6	%
Cladding Non-Circularity		≤2 1		≤2 1	%
Core/Cladding Offset		≤3		≤3	um
Coating Diameter		245±10		245±10	um
Proof-Test Level		100 (0.7)		100 (0.7)	Kpsi (GN/m ²)
Fatigue Coefficient		≥20		≥20	
Temperature Dependence between 0°C ~ +70°C		0.1		0.1	dB



Mechanical & Environmental Properties for Single Mode Fiber

Testing Parameters	EIA/TIA-455 FOTP Number	IEC-794-1 Test Method	EN 187000 Test Method	Maximum Increased loss
Tensile Load & Bending	33	E1	501	<0.05dB (90%); <0.15dB (100%)
Low & High Temperature Bend	37	E11		<0.05dB (90%); <0.15dB (100%)
Compression loading (Crush)	41	E3	504	<0.05dB (90%); <0.15dB (100%) 440N/km(250lb/in) load
Impact Resistance	25	E4	505	<0.05dB (90%); <0.15dB (100%)
Twist (Torson)	85	E7	508	<0.05dB (90%); <0.15dB (100%)
Cyclic Flexing (Repeated Bending)	104	E6	509	<0.05dB (90%); <0.15dB (100%)
External freezing	98	F6		<0.05dB (90%); <0.15dB (100%)
Temperature Cycling	3	F1	601	<0.05dB (90%); <0.15dB (100%)
Fiber Stripability	178	B6		<8.9N(2lbf) on unaged and aged fiber; >1.3N(0.3lbf) on unaged and aged fiber
Cable Aging	82	F5		<0.1dB (90%); <0.25dB (100%)
Water Penetration	82	F5		No flow after 24 hours from 1 meter length of cable
Compound Flow (Drip)	81	E14		80°C 24 hours duration, no drip

Mechanical & Environmental Properties for Multi Mode Fiber

Testing Parameters	EIA/TIA-455 FOTP Number	IEC-794-1 Test Method	EN 187000 Test Method	Maximum Increased loss
Tensile Load & Bending	33	E1	501	<0.2dB
Low & High Temperature Bend	37	E11		<0.4dB
Compression loading (Crush)	41	E3	504	<0.2dB 440N/km(250lb/in) load
Cyclic Impact	25	E4	505	<0.4dB
Twist (Torsion)	85	E7	508	<0.2dB
Cyclic Flexing (Repeated Bending)	104	E6	509	<0.2dB
External freezing	98	F6		<0.2dB
Temperature Cycling	3	F1	601	<0.05dB (90%); <0.15dB (100%)
Fiber Stripability	178	B6		<13.4N(3lbf) on unaged fiber
Cable Aging	82	F5		<0.1dB (90%); <0.25dB (100%)
Water Penetration	82	F5		No flow after 24 hours from 1 meter length of cable
Compound Flow (Drip)	81	E14		80°C 24 hours duration, no drip



Technical Information

FLAME RETARDANCE IN ACCORDANCE WITH DIFFERENT STANDARDS

The following standards specify a method for flame propagation test for single core cables. The single cable sample undergoes the flame action of a bunsen burner. The test only lasts few minutes.

The IEC 60332-1 standards are taken over as EN standards and transferred to national standards Example: IEC 60332-1 becomes EN 60332-1 and introduced in Germany as DIN EN 60332-1.

Flame Retardance in accordance with EN 60332:2004

EN 60332:2004 Tests on electrical and optical cables under fire conditions. The standard applies to single insulated wires (cables) and requires a vertical flame test with a maximum flame climb of 450mm. The test lasts between 1 and 8 minutes, depending on the cable diameter.

EN 60332-1-1:2004 / BS EN 60332-1-1:2004 / IEC 60332-1-1:2004 / DIN EN 60332-1-1:2004 / VDE 0482-1-1:2005-06 Test on electrical and optical cables under fire conditions. Test for a vertical flame propagation for a single insulated wire or cables.

EN 60332-1-2:2004 / BS EN 60332-1-2:2004 / IEC 60332-1-2:2004 / DIN EN 60332-1-2:2004 / VDE 0482-1-2:2005-06 / CEI 60332-1-2(CEI 20-35/1-2) Tests on electrical and optical fiber cables under fire conditions. Test for a vertical flame propagation for a single insulated wire or cable – Procedure for 1kW premixed flame.

This standard specifies a method of test for resistance to vertical flame propagation for a single insulated wire or cable. Part 1-1 specifies the test apparatus and Part 1-2 specifies the test procedure.

The cable sample is deemed to pass the test if the distance between the lower edge of the top support and the onset of charring is greater than 50mm. In addition, a failure shall be recorded if burning extends downward to a point greater than 540mm from the lower edge of the top support.

EN 60332-1-2:2004 specifies the use of 1kW premix flame and is for general use, except that the procedure may not be suitable for the testing of small insulated conductors or cables of less than 0.5mm sq cross section because the conductor melts before the test is completed, or for the testing of small optic fiber cables because the fiber will be broken before the test is completed. In this case, the procedure given by EN 60332-2-1/2 is recommended.

EN 60332-2-1:2004 / BS EN 60332-2-1:2004 / IEC 60332-2-1:2004 / DIN EN 60332-2-1:2004 / VDE 0482-2-1:2005-06 Tests on electrical and optical cables under fire conditions. Test for a vertical flame propagation for a single small insulated wire or cable.

EN 60332-2-2:2004 / BS EN 60332-2-2:2004 / IEC60332-2-2:2004 / DIN EN 60332-2-2:2004 / VDE 0482-2-2:2005-06 / CEI 60332-2-2 (CEI 20-35/2-2) Test on electric and optical fiber cables under fire conditions. Tests for vertical flame propagation for a single small insulated wire or cable. Procedure for diffusion flame.

This test applies to small dimensions cables.

This standard specifies a method of test for resistance to vertical flame propagation for a single

insulated wire or cable. Part 2-1 specifies the test apparatus and Part 2-2 specifies the test procedure.

Flame Retardance in accordance with NF C32-070-2.1(C2)

NF C32-070:2001 Insulated conductors and cables for installation - Classification tests on conductors and cables with regard to fire behavior.

NF C32-070 2.1 Procedure for 1 kW pre-mixed flame.

The NF F 32070 2.1 (Category C2) and IEC 60332-1-2 are very similar. The sole difference is the time during which the flame is applied.

Flame Retardance in accordance with EN 50265-1:1999 (replaced by EN 60332)

EN 50265-1:1999 / BS EN 50265-1:1999 / DIN EN 50265-1:1999 / VDE 0482-265-1:1999-04 – Common test methods for cables under fire conditions. Test for resistance to a vertical flame propagation for a single insulated conductor or cable. Apparatus (Replaced by EN 60332-1-1:2004 and EN 60332-2-1:2004).

EN 50265-2-1:1999 / BS EN 50265-2-1:1999 / DIN EN 50265-2-1:1999 / VDE 0482-265-2-1:1999-04 – Common test methods for cables under fire conditions. Test for resistance to a vertical flame propagation for a single insulated conductor or cable. Part 2-1: Procedure 1kW pre-mixed flame (Replaced by EN 60332-1-2:2004).

EN 50265-2-2:1999 / BS EN 50265-2-2:1999 / DIN EN 50265-2-2:1999 / VDE 0482-265-2-2:1999-04 – Common test methods for cables under fire conditions. Test for resistance to a vertical flame propagation for a single insulated conductor or cable. Part 2-2: Procedure Diffusion flame (Replaced by EN 60332-2-2:2004).

Flame Retardance in accordance with BS 4066 Part 1 & 2 (replaced by EN 60332)

BS 4066-2:1980 (superseded) – Tests on electric cables under fire conditions. Method of test on a single vertical insulated wire or cable.

This standard is no longer in force and is replaced by BS EN 50265-2-1 which was also superseded by BS EN 60332-1:2009.

Flame Retardance in accordance with NBN C 30-004 (cat. F1)

NBN C 30-004 specifies a method of test for measuring the vertical flame propagation characteristics of a single wire or cable. The cable specimen is deemed to have passed the test and categorized as F1 if after burning has ceased, the charred or affected portion does not reach within 50mm of the lower edge of the top clamp which is equivalent to 425mm above the point of flame application.

Flame Retardance in accordance with IEEE 383

In the IEEE 383 test, cables are supported by a one foot wide vertical rack eight feet high. The cables are positioned in the centre six inches of the rack, spaced one-half diameter apart. The rack is centered in an eight foot enclosure. A ten inch ribbon burner ignites the cable with a 21 kW (70000 BTU). The burner is positioned 2 feet above the floor and 9 to 12 inches of cables are exposed to direct flames for 20 minutes. Cables on which flame extends above the top of the 8 foot rack fail the test.



REDUCED FIRE PROPAGATION IN ACCORDANCE WITH DIFFERENT STANDARDS

These standards specify a method for fire propagation test for vertically mounted bunched cables. These tests simulate the chimney effect in vertical installation of bunch of cables. A certain number of cable sections with a length of 3.5 m is fastened to a vertical ladder in an adapted chamber. The amount of combustible materials for cables and duration of flame application depends on the category the cable has to meet.

Resistance of the wires bundle arranged vertically to the spread of the flame should be such that after a certain time and stopping the source of ignition, flame is extinguished by itself and the length of charred fragments will not exceed 2.5 m in height measured above the lower edge of the burner.



Reduced Fire Propagation in accordance with IEC 60332-3

This test is the most common one to verify the behaviour of a cables for the fire propagation. The cables are installed on a bunch of vertical ladder inside a metal cabinet and undergo the action of a ribbon flame at 750°C. The standard is subdivided in several parts that differ one from the other for the quantity of cable to be installed, the installation mode and the flame application time.

EN 60332-3-10:2009 / BS EN 60332-3-10:2009 / IEC 60332-3-10 ed1.1 / DIN EN 60332-3-10:2009 / VDE 0482-332-3-10:2010-08 – Common test methods for cables under fire conditions. Tests on electric and optical fiber cables under fire conditions - Part 3-10: Test for vertical flame spread of vertically mounted bunched wires or cables.

EN 60332-3-21:2009 / BS EN 60332-3-21:2009 / IEC 60332-3-21 ed1.1 / DIN EN 60332-3-21 / VDE 0482-332-3-21:2010-08 / CEI EN 60332-3-21:2009 (CEI 20-22/3-1)– Procedures. Tests on electric and optical fiber cables under fire conditions - Part 3-21: Test for vertical flame spread of vertically-mounted bunched wires or cables - Category A . F/R

- Installation In one layer (front).
- Installation In two layers (front and rear)
- The quantity of the Installed cable is equal to 7 litres/m of combustible materials for cables
- The time of application of the flame is 40 minutes

EN 60332-3-22:2009 / BS EN 60332-3-22:2009 / IEC 60332-3-22 ed1.1 / DIN EN 60332-3-22:2009 / VDE 0482-332-3-22:2010-08 / CEI EN 60332-3-22:2009 (CEI 20-22/3-2)– Procedures. Tests on electric and optical fiber cables under fire conditions - Part 3-22: Test for vertical flame spread of vertically-mounted bunched wires or cable - Category A

- Installation In one layer (front).
- The quantity of the installed cable is equal to 7 litres/m of combustible materials for cables
- The time of application of the flame is 40 minutes

EN 60332-3-23:2009 / BS EN 60332-3-23:2009 / IEC 60332-3-23 ed1.1 / DIN EN 60332-3-23:2009 / VDE 0482-332-3-23:2010-08 / CEI EN 60332-3-23:2009 (CEI 20-22/3-3)– Procedures. Tests on electric and optical fiber cables under fire conditions - Part 3-23: Test for vertical flame spread of vertically-mounted bunched wires or cables - Category B

- Installation In one layer (front).
- The quantity of the installed cable is equal to 3.5 litres/m of combustible materials for cables
- The time of application of the flame is 40 minutes

EN 60332-3-24:2009 / BS EN 60332-3-24:2009 / IEC 60332-3-24 ed1.1 / DIN EN 60332-3-24:2009 / VDE 0482-332-3-24:2010-08 / CEI EN 60332-3-24:2009 (CEI 20-22/3-4) – Procedures. Tests on electric and optical fiber cables under fire conditions - Part 3-24: Test for vertical flame spread of vertically-mounted bunched wires or cables - Category C

- Installation In one layer (front).
- The quantity of the installed cable is equal to 1.5 litres/m of combustible materials for cables
- The time of application of the flame is 20 minutes



EN 60332-3-25:2009 / BS EN 60332-3-25:2009 / IEC 60332-3-25 ed1.1 / DIN EN 60332-3-25: 2009 / VDE 0482-332-3-25:2010-08 / CEI EN 60332-3-25:2009 (CEI 20-22/3-5)– Procedures. Tests on electric and optical fiber cables under fire conditions - Part 3-25: Test for vertical flame spread of vertically-mounted bunched wires or cables - Category D

- Installation In one layer (front).
- The quantity of the installed cable is equal to 0.5 litres/m of combustible materials for cables
- The time of application of the flame is 20 minutes.

Summary of test condition:

IEC	60332-3-21	60332-3-22		60332-3-23		60332-3-24		60332-3-25	
BS EN 50266	50266-2-1	50266-2-2		50266-2-3		50266-2-4		50266-2-5	
CEI	20-22/3-1	20-22/3-2		20-22/3-3		20-22/3-4		20-22/3-5	
Category	AF/R	A		B		C		D	
Conductor cross-sections mm ²	>35	>35	≤35	>35	≤35	>35	≤35	>35	≤35
NMV(litres per metre of cable)	7	7		3.5		1.5		0.5	
Minimum length of test pieces(m)	3.5	3.5		3.5		3.5		3.5	



Standard ladder (500 mm wide): • number of layers • maximum width of test sample	1front+1rear 300mm	≥1front 300mm	1front 300mm	- -	≥1front 300mm	1front 300mm	≥1front 300mm	1front 300mm	≥1front 300mm
Wide ladder (800 mm wide): • number of layers • maximum width of test sample	- -	- -	- -	1front 600mm	- -	- -	- -	- -	- -
Positioning of test pieces	Spaced 0.5×Diameter cable (Max.20mm)	Touching	Spaced 0.5×Diameter cable (Max.20mm)	Touching	Spaced 0.5×Diameter cable (Max.20mm)	Touching	Spaced 0.5×Diameter cable (Max.20mm)	Touching	Touching
Number of burners	1	1	1	2	1	1	1	1	1
Ladder mounting	Front and rear	Front, Wider ladder for larger cables			Front	Front	Front	Front	Front
Flame application time(min)	40	40	40	40	40	40	40	40	40
Test conditions	Wind speed: <8 m/s; Temperature: 5°C - +40°C								
Extent of the charred portion	≤2.5m above the bottom edge of the burner, neither at the front nor at the rear of the ladder.								

Reduced fire propagation in accordance with NF C32-070-2.2(C1)

NF C32-070 :2001 Insulated conductors and cables for installation.

-Classification tests on conductors and cables with regard to fire behavior.

A 1600mm vertically installed bundled of cable is exposed to the effects of a radiating oven (approx 830°C) and forced ventilation. Pilot flames arranged above the oven burn off the emitted gases. The test duration is 30 minutes, with the ventilation stopped for every 10 minutes during the flame application period. The cable sample is classified under Category C1 according to NF F 32070-2.2 if the carbonised part of the cable sample does not extend more than 0.8m above the upper base of the oven.

Depending on the damaged length, they can be further classified into 4 classes A, B, C and D according to NF F 16-101 as follows:

Category	Test Result
A	No damaged length from top of the oven in upper position.
B	Damaged length from top of oven in upper position not extending more than 50mm.
C	Damaged length from top of oven in upper position not extending more than 300mm
D	Damaged length from top of oven in upper position not extending above the top of the chimney

Reduced Fire Propagation in accordance to EN 50266-1, EN 50266-2-2, EN 50266-2-3, EN 50266-2-4.

EN 50266-1:2001 / BS EN 50266-1:2001 / DIN EN 50266-1:2001 / VDE 0482-266-1:2001-09– Common test methods for cables under fire conditions. Test for vertical flame spread of vertically mounted bunched wires or cables - Part 1: Apparatus (Replaced by EN 60332-3-10:2009)

EN 50266-2-1:2001 / BS EN 50266-2-1:2001 / DIN EN 50266-2-1:2001 / VDE 0482-266-2-1:2001-09 / CEI EN 50266-2-1– Common test methods for cables under fire conditions. Test for vertical flame spread of vertically mounted bunched wires or cables - Part 2-1 : Procedures. Category A F/R (Replaced by EN 60332-3-21:2009)

EN 50266-2-2:2001 / BS EN 50266-2-2:2001 / DIN EN 50266-2-2:2001 / VDE 0482-266-2-2:2001-09 / CEI EN 50266-2-2– Common test methods for cables under fire conditions. Test for vertical flame spread of vertically mounted bunched wires or cables - Part 2-2: Procedures. Category A (Replaced by EN 60332-3-22:2009)



EN 50266-2-3:2001 / BS EN 50266-2-3:2001 / DIN EN 50266-2-3:2001 / VDE 0482-266-2-3:2001-09 / CEI EN 50266-2-1– Common test methods for cables under fire conditions. Test for vertical flame spread of vertically mounted bunched wires or cables - Part 2-3: Procedures. Category B (Replaced by EN 60332-3-23:2009)

EN 50266-2-4:2001 / BS EN 50266-2-4:2001 / DIN EN 50266-2-4:2001 / VDE 0482-266-2-4:2001-09 / CEI EN 50266-2-4:2001 – Common test methods for cables under fire conditions. Test for vertical flame spread of vertically mounted bunched wires or cables - Part 2-4: Procedures. Category C (Replaced by EN 60332-3-24:2009).

Reduced Fire Propagation in accordance with BS 4066-3

BS 4066-3:1994 (superseded) – Tests on electric cables under fire conditions. Tests on bunched wires or cables.

This standard is no longer in force and is replaced by the BS EN 50266-1:2001

Reduced Fire Propagation in accordance with NBN C 32-004 (F2)

NBN C 32-004 specifies a method of test for measuring the vertical flame propagation characteristics of a bunch of cables. The cable specimen is deemed to have passed the test and categorized as F2 if after burning has ceased, the extent of charred or affected portion does not reach a height exceeding 2.5m above the bottom edge of the burner.

HALOGEN CONTENT TEST IN ACCORDANCE WITH DIFFERENT STANDARDS

In the event of a fire, many fumes are produced. This test is concerned with the possibilities of corrosive acid gases being released from halogen containing cables and the damage such cables can cause (to equipments). These standards specify a method for determination of the amount of halogen acid gas, evolved during combustion of compound.



Halogen Content Test in accordance with EN 50267-2-1

EN 50267-2-1:1998 / BS EN 50267-2-1:1999 / DIN EN 50267-2-1:1999 / VDE 0482-267-2-1:1999-04 / CEI EN 50267-2-1:1999 (CEI 20-37/2-1) Common test methods for cables under fire conditions- Test on gases evolved during combustion of materials from cables- Part 2-1: Procedures. Determination of the amount of halogen acid gas.

This part of the standard defines the method to measure the amount of halogen acid evolved and which should be expressed in hydrochloric acid. The amount of halogen acid contained in the test solution is determined by a titration method.

If the cables are described as zero halogen or halogen free, it is recommended that the hydrochloric acid yield should be less than 0.5%.



Halogen Content Test in accordance with IEC 60754-1

IEC 60754-1 ed 2.0 Common test methods for cables under fire conditions. Test on gases evolved during combustion of materials from cables. Part 1: Procedures. Determination of the amount of halogen acid gas.

Basically, this is same as EN 50267-2-1.

Halogen Content Test in accordance with BS 6425-1

BS 6425-1:1990(superseded): Test on gases evolved during the combustion of materials from cables. Method for determination of amount of halogen acid gas evolved during combustion of polymeric materials taken from cables.

This standard is no longer in force and is replaced by the EN 50267-2-1.

ACID GAS EMISSION TEST IN ACCORDANCE WITH DIFFERENT STANDARDS

The following standards specify a method for determination of acidity of gas evolved during combustion of cables by measuring PH and conductivity. This test allows to determine the corrosivity of the acid gases generally halogens, that develop during the electric cable combustion.

Acid Gas Emission Test in accordance with EN 50267-2-2

EN 50267-2-2:1999 / BS EN 50267-2-2:1999 / DIN EN 50267-2-2:1999 / VDE 0482-267-2-2:1999-04 / CEI EN 50267-2-2:1999 (CEI 20-37/2-2). Common test methods for cables under fire conditions- Test on gases evolved during combustion of materials from cables- Part 2-2: Procedures. Determination of degree of acidity of gases for materials by measuring PH and conductivity

The standard states that the pH and the conductivity of a test solution should be measured, using calibrated PH and conductivity meters.

If the cables are described as zero halogen or halogen free, it is recommended that at least both of the following requirements should be met for each of the individual materials of a cable:

-The PH value should not be less than 4.3 when related to 1 litre of water



-The conductivity should not be less than 10us/mm when related to 1 litre of water

EN 50267-2-3:1999 / BS EN 50267-2-3:1999 / DIN EN 50267-2-3:1999 / VDE 0482-267-2-3:1999-04 / CEI EN 50267-2-3:1999 (CEI 20-37/2-3). Common test methods for cables under fire conditions- Test on gases evolved during combustion of materials from cables- Part 2-3:Procedures. Determination of degree of acidity of gases for cables by determination of the weighted average of pH and conductivity.

The standard states that the pH and the conductivity of a test solution should be measured, using calibrated pH and conductivity meters. The results from the different components of the cable are then weighted.

Acid Gas Emission Test in accordance with IEC 60754-2

IEC 60754-2 ed1.0 Test on gases evolved during combustion of electric cables - Part 2 : Determination of degree of acidity of gases evolved during combustion of materials taken from electric cables by measuring pH and conductivity.

Acid Gas Emission Test in accordance with NF C32-074

NF C32-074 Common test methods for cables under fire conditions - Test on gases evolved during combustion of materials from cables. This standard is equivalent to IEC 60754-2

Acid Gas Emission Test in accordance with BS 6425-2

BS 6425-2:1993 (superseded) Test on gases evolved during the combustion of materials from cables.

Determination of degree of acidity (corrosivity) of gases by measuring pH and conductivity.

This standard is no longer in force and is replaced by the EN 50267-2-2:1999.

Acid Gas Emission Test in accordance with DIN VDE 0472-813 / VDE 0472-813:1994

DIN VDE 0472-813 / VDE 0472-813:1994 Corrosivity of combustion gases.

The standards are no longer in force and are replaced by the EN 50267-2-2 & VDE 0482-267-2-2.

SMOKE DENSITY TEST IN ACCORDANCE WITH DIFFERENT STANDARDS

The smoke density measurement taken from a material under fire conditions gives an indication of the visibility through the smoke. This is important as reduced visibility in a real fire situation makes it more difficult to escape from the fire thus increasing the threat to human life from the toxic gas, fumes and heat

The following standards specify the method for measuring the generation of smoke from cables during fire.

Smoke Density Test in accordance with IEC 61034-1 & IEC 61034-2

IEC 61034-1:2005 / EN 61034-1:2005 / BS EN 61034-1:2005 / DIN EN 61034-1:2006 / VDE 0482-1034-1:2006 Measurement of smoke density of cables burning under defined conditions. Part 1: Test





apparatus

IEC 61034-2:2005 / EN 61034-2:2005 / BS EN 61034-2:2005 / DIN EN 61034-2:2006 / VDE 0482-1034-2:2006 / CEI EN 61034-2:2006 (CEI 20-37/3-1) Measurement of smoke density of cables burning under defined conditions.

Part 2: Test procedure and requirements.

The standard specifies a method of measurement of smoke density of cables. Part 1 specifies the test apparatus and Part 2 specifies the test procedure.

The test is usually performed inside a chamber of 3m x3m x3m and the test is sometimes described as 3 metre cube test. The test is performed by monitoring the transmittance reduction of a white light beam, running from one side of the chamber to the other, at a set height, thus monitoring the build up of smoke inside the chamber. The minimum percentage of light transmittance is often used to determine if the cable has passed or failed the test, often a minimum light transmittance of 60% is applied in order to classify a cable as low smoke.

Smoke Density Test in accordance with NF C32- 073

NF C32 073 Common test methods for cables under fire conditions.

- Measurement of smoke density of cables burning under defined conditions.

This standard is equivalent to IEC 61034-2

Smoke Density Test in accordance with BS 7622-1 & BS 7622-2

BS 7622-1:1993 (superseded) – Measurement of smoke density of electric cables burning under defined conditions. Test apparatus.

BS 7622-2:1993 (superseded) – Measurement of smoke density of electric cables burning under defined conditions. Test procedure and requirements.

The standards are no longer in force and were replaced by the EN 50268-1:2000 and EN 50268-2:2000 even though they too were superseded by EN 61034-1:2005 and EN 61034-2:2005.

Smoke Density Test in accordance with EN 50268-1 & EN 50268-2

EN 50268-1:2000 / BS EN 50268-1:2000 / DIN EN 50268-1:2000 / VDE 0482-268-1:2000 (superseded) – Common test methods for cables under fire conditions. Measurement of smoke density of cable burning under defined conditions. Part 1: Apparatus

EN 50268-2:2000 / BS EN 50268-2:2000 / DIN EN 50268-2:2000 / VDE 0482-268-2:2000 (superseded) – Common test methods for cables under fire conditions. Measurement of smoke density of cable burning under defined conditions. Part 2: Procedure.

The standards are no longer in force and are replaced by the EN 61034-1:2005 and EN 61034-2:2005. Although these standards have been withdrawn, they are still called upon in some specification documents such as in the London Underground specification 1-085.

Smoke Density Test In Accordance with DIN VDE 0472-816 / VDE 0472-816:1994

DIN VDE 0472-816/VDE 0472-816:1994 Testing of cables, wires and flexible cords. Smoke Density.

The standards are no longer in force and are replaced by the EN 50268-1, VDE 0482-268-1, EN 50268-2 & VDE 0482-268-2 which are also replaced by the EN 61034-1:2005 and EN 61034-

2:2005.

OXYGEN INDEX TEST IN ACCORDANCE WITH DIFFERENT STANDARDS

The oxygen index is defined as the minimum concentration of oxygen, expressed as volume percentage, in a mixture of oxygen and nitrogen that will just support combustion of a material initially at room temperature under specified test conditions.

Oxygen Index Test in accordance with ASTM D 2863

ASTM D 2863-10 Measuring the minimum oxygen concentration to support candle-like combustion of plastics (Oxygen Index).

The test is performed in accordance with the procedure specified in ASTM 2863-95 using test piece cut from the outer sheath of the cable. The apparatus holds a small specimen which is clamped vertically in a tube in an atmosphere where the relative concentration of oxygen and nitrogen can be changed. The aim is to test the flammability of the sample with a small pilot flame to find the minimum oxygen concentration required to just sustain combustion of the sample.



Oxygen Index Test in accordance with ISO 4589-2

ISO4589-2:1996 Determination of burning behaviour by oxygen index Part 2: Ambient temperature test.

Specimens measuring 100mm long by 6mm wide are used for testing. The test is performed in accordance with the procedure specified in the standard.

TEMPERATURE INDEX TEST IN ACCORDANCE WITH DIFFERENT STANDARDS

This is a test for assessing the performance of a material when it is tested in accordance with BS2782: Part 1: Method 143a and 143b. The oxygen index of a material will drop when the temperature rises. When the temperature rises and the oxygen index drops to 21%, the material will burn automatically. This temperature is defined as temperature index. For example, the oxygen index of the coal at room temperature is 50% and when the temperature climbs to 150°C, its oxygen index drops to 21% and the coal will burn by itself automatically. The temperature index of the coal is defined as 150°C. In general, the temperature index of fire retardant cable exceeds 250°C.



Temperature Index Test in accordance with BS 2782

BS 2782: Part 1:1989 Method 143a and 143b Temperature of materials. Determination of flammability.

Specimens measuring nominally 100mm long by 6.5mm wide by 3mm thick are used for testing. The specimens are then tested in accordance with the test procedure specified in the standard.

Temperature Index Test in accordance with ISO 4589-3

ISO4589-3:1996 Determination of burning behaviour by oxygen index Part 3: Elevated temperature



test.

Specimens measuring 100mm long by 6mm wide are used for testing. The test is performed in accordance with the procedure specified in the standard.

TOXICITY TEST IN ACCORDANCE WITH DIFFERENT STANDARDS

Toxicity test in accordance with NES 02-713

Measuring a fume from a material exposed to a controlled fire conditions gives an indication of the fumes which may be produced in a real fire situation. A standard method of test for determining the toxicity of materials under fire condition is Defense Standard NES 02-713- Toxicity. This method gives the level of toxicity of the fumes produced from the material under test. During the test, the test specimen is heated via direct flame application at 1150°C.

The flame is applied via a bunsen burner with a flame height of between 100mm and 125mm formed with a methane gas and an external supply of compressed air. The specimen toxicity is determined from accurate pre-analysis weight (4pp) colorimetric tubes and ion chromatography.

The test may determine the following species: Hydrogen Bromide, Hydrochloric Acid, Hydrogen Fluoride, Formaldehyde, Nitrous gases, Carbon Monoxide, Carbon Dioxide, Acrylonitrile, Phenol, Hydrogen Sulphide, Sulphur Dioxide, Hydrocyanic Acid, Ammonia. The concentration in ppm for each gas detected are provided. The toxicity index of the specimens summates the toxic gases, taking into account of their level of danger to humans. The smaller the toxicity index, the better the product. A limit of 5 is often applicable.



Toxicity test in accordance with NF C 20-454

NF C 20-454 base environmental testing procedures. Fire behaviour. Analysis and titration of gases evolved during pyrolysis or combustion of materials used in electrotechnics. Exposure to abnormal heat or fire. Tube furnace method.

The test defined by this standard serves to define the conventional toxicity index (cti) of the gases emitted by the insulating or sleeving materials during combustion at 800°C.

Toxicity test in accordance with NF X 70-100

NF X 70-100 Fire Tests; Analysis of gaseous effluents.

The test is conducted within a tube furnace where the temperature is set at either 400°C, 600°C, 800°C (commonly 600°C is used for most of the materials or 800°C for some electrical products) for 40 minutes throughout the test by analysis of the toxicity index of the gases including CO, CO₂, HCL, HBr, HCN, HF and SO₂.



Address:

**Marchants Industrial Centre, Mill Lane, Laughton, Lewes,
East Sussex, BN8 6AJ, UK**

Tel: 44(0) 207 4195087

Fax: 44(0) 207 8319489

E-mail: sales@caledonian-cables.co.uk

www.caledonian-cables.co.uk

